

System Administrator's Update

Please read these notes before installing Microsoft XENIX Multiplan on your system.

XENIX System Requirements

To run Multiplan, you must have Microsoft XENIX System V (the manual incorrectly refers to version 3.0) or IBM XENIX 286 Version 2, installed on your hard disk.

Depending on your system configuration and number of users, you may need more than 640K of memory to run Multiplan.

Setting the MSPLAN Environment Variable

To run Multiplan, you must set the environment variable MSPLAN to designate the path to the Multiplan *termcap* file. Multiplan's *termcap* file is usually in the same directory as the Multiplan program. To set the environment variable when *termcap* is in /usr/mp:

For C Shell users, type this line in the .login file:

- `setenv MSPLAN /usr/mp`

For Bourne Shell users, type this line in the .profile file:

- `set MSPLAN = /usr/mp ; export MSPLAN`

Utilities Disk

The Multiplan Utilities disk includes sample XENIX Multiplan models. To copy the models to your hard disk:

- 1 At the system prompt, type `tar -xvf /dev/fd048`
- 2 Press the RETURN key.

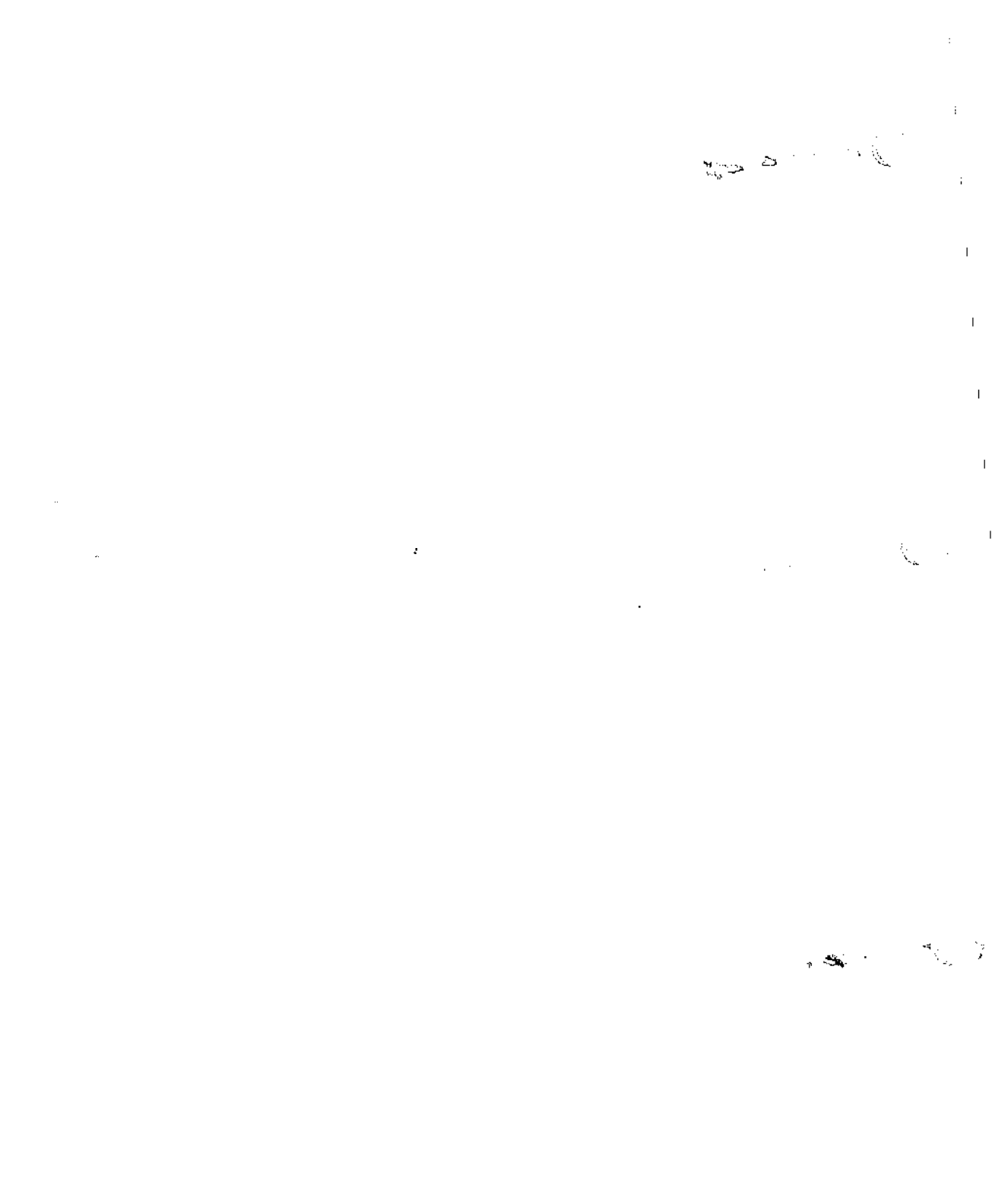

MICROSOFT®

The High Performance Software™



Microsoft® Multiplan®

**Electronic Worksheet Program
Version 2.0**

for the XENIX® Operating System

Information in this document is subject to change without notice and does not represent a commitment on the part of Microsoft Corporation. The software described in this document is furnished under a license agreement or nondisclosure agreement. The software may be used or copied only in accordance with the terms of the agreement. It is against the law to copy Microsoft Multiplan on magnetic tape, disk, or any other medium for any purpose other than the purchaser's personal use.

© Copyright Microsoft Corporation, 1982, 1983, 1984, 1985, 1986

If you have comments about this documentation or the enclosed software, complete the Software Problem Report at the back of this manual and return it to Microsoft.

Microsoft, the Microsoft logo, and Multiplan are registered trademarks, and The High Performance Software is a trademark, of Microsoft Corporation.

MS and MS-DOS are registered trademarks of Microsoft Corporation.

XENIX is a registered trademark of Microsoft Corporation.

ADM-3A is a trademark of Lear Siegler Incorporated, Data Products Division.

Datavue is a registered trademark of Datavue Corporation.

DEC is a registered trademark and 100 is a trademark of Digital Equipment Corporation.

Heath is a registered trademark of Heath Corporation.

IBM is a registered trademark of International Business Machines Corporation.

Lotus and 1-2-3 are registered trademarks, and Symphony is a trademark, of Lotus Development Corporation.

TeleVideo is a registered trademark of TeleVideo Systems, Inc.

VisiCalc is a registered trademark of VisiCorp, Inc.

Zenith is a registered trademark of Zenith Radio Corporation.

Zentec is a registered trademark of Zentec Corporation.

Document Number: 290320004-200-R00-0686

Part Number: 023-092-003

Important

- Throughout this manual you will find references to diskettes. Due to the numerous different configurations of machines operating under XENIX®, use of diskettes may not apply to you. For example, if Multiplan® is already installed on your machine, you do not require a Multiplan Program diskette. You can start Multiplan at the system prompt simply by typing *mp* and then pressing RETURN.
Also, you will generally save worksheets on a hard disk instead of on data diskettes.
- Although this manual refers to the WINDOWS PAINT command, the command is not present in this version of Multiplan.

Preface

Microsoft® Multiplan is a personal productivity tool that will help you analyze data. As an aid for both business and personal needs, Multiplan is one of the most powerful modeling and planning tools ever invented. With Multiplan you can do the capital budgeting for a small company; you can make major sales force decisions or analyze product planning; you can plan your personal investments and put together a budget for your family. . . and much more.

Multiplan is easy to learn, and its versatility is enhanced by the skill of its user. As you become more familiar with Multiplan, and better able to exercise its powers, you'll be surprised at how quickly and efficiently you'll accomplish various tasks.

The two parts of this manual are designed as a tutorial and a reference guide to Multiplan. Part 1, "Using Multiplan," is the tutorial, which gives you an overview of the features of the system. Part 2, "Reference to Multiplan," is a detailed reference guide to all Multiplan features. Parts 1 and 2 complement one another; together, they will teach you both the concepts and the uses of Multiplan.

The design of Multiplan allows you to work intuitively; its capabilities allow you to accomplish a wide variety of tasks.

Welcome! We hope you enjoy working with your powerful new assistant: Microsoft Multiplan.

Contents

Introduction	xi
Getting Started	xv
Operating Information	xxi

Using Multiplan

2

1 Fundamentals 5

The Screen	5
The Direction Keys	7
Moving the Cell Pointer	8
The Status Line	9
Scrolling the Worksheet	12
The Goto (G) Command	14
Command Selection from Menus	17
Multiplan Proposed Responses	18
Filling in the Command Line: The TAB Key	18
Carrying Out a Command: The RETURN Key	19
Canceling a Command: The CANCEL Key	19
The Help (H) Command	20
The Quit (Q) Command	21
Summary	22

2 Building a Worksheet 23

The Worksheet Number Grid	24
Entering Text: The Alpha (A) Command	25
Correcting Typing Errors: The BACKSPACE Key	28
Entering Data with the Direction Keys	29
Column Width	32
The Format Width Command	32
Entering Numbers	34
The Format Default Cells Command	36
Alignment	37
Formats	38
Saving Work: The Transfer Save Command	41
The Quit (Q) Command	42
Summary	43

3 Entering Formulas 45

Loading a File: The Transfer Load Command	45
The Insert Command	47

Entering Additional Text	49
Entering Additional Numbers	50
Aligning Cell Contents	51
Ranges: The Colon	53
The Blank Command	55
Formulas	57
Building a Formula	57
Reviewing or Changing a Formula	64
The Status Line: Cell Contents	64
Drawing Lines	65
The Transfer Save Command (Review)	67
Summary	68
4 Naming Cells and Copying	69
The Transfer Load Command (Review)	69
Titles	70
Format: Align Center	74
The Copy Right Command	75
Formulas (Review)	80
Naming Cells	80
Building a Formula Using Names	84
The Goto Name Command	87
Calculating Functions: SUM	90
Number Signs (#)	93
Error Values	94
Relative and Absolute References	96
Copying a Formula: The Copy From Command	100
Summary	103
5 Windows, Copying Formulas, and Options	105
Fixing Titles: The Window Split Title Command	106
Opening a Window: The Window Split Command	108
Linking Windows: The Window Link Command	110
Bordering Windows: The Window Border Command	111
Building a Formula to Show Increasing Sales	113
Copying a Formula to the Right: The Copy Right Command (Review)	116
What If...?	118
Protecting the Worksheet: The Lock Formulas Command	119
The NEXT UNLOCKED CELL Key	119
Unlocking Cells	121
The Options Command	122
Summary	125
6 Printing a Worksheet	127
The Print Command	127
The Print Printer Command	128
Other Print Subcommands	130
Summary	131

7 Using Multiple Worksheets	133
Relating Worksheets to Each Other	135
The Transfer Clear Command	135
Building a Supporting Sheet	136
Naming Related Worksheets	140
The eXternal Copy Command	141
Revising a Supporting Sheet	148
Dissolving Connections between Worksheets	150
The eXternal List Command	153
Summary	154

Reference to Multiplan

156

8 Elements of Multiplan	159
The Microsoft Multiplan Worksheet	159
Entering Commands	161
Select a Command	162
Select Responses for the Command Fields	163
Proposed Responses	164
Editing	164
Formulas	166
Numbers	167
Text	168
References to Cells	169
Logical Values	177
Error Values	178
Files	179
File Handling	179
Problems with File Access	180
External Relationships	181
Transforming the Worksheet	183
Using Worksheets from Other Programs	184A

9 Commauds 185

Alpha	186
Blank	188
Copy	188
Delete	193
Edit	195
Format	196
Goto	204
Help	207
Insert	208
Lock	210
Move	212
Name	214

- Options 216
- Print 217
- Quit 220
- Sort 221
- Transfer 222
- Value 228
- Window 229
- eXternal 237

10 Functions 245

11 Messages 293

Appendices

302

A Macros 305

- A Simple Example 305
- Creating Macros 307
- A Second Example 315

B Solving Extended Problems with the Iteration Option 319

- The Iteration Option and Supporting Functions 322
- Options 322
- DELTA() 324
- ITERCNT() 326
- Creating Iteration Models 328
- Summary of Hints for Creating Iteration Models 338

Lexicon 341

Index 347

Figures

Chapter 4 Naming Cells and Copying 69

- 1 Copied Absolute Formulas Refer to the Same Cells 97
- 2 Copied Relative Formulas Refer to Different Cells 98

Chapter 8 Elements of Multiplan 159

- 3 Cell Reference Gives Access to a Value 169
- 4 Relative Cell Reference 170
- 5 Comparison of Absolute and Relative References 172
- 6 Names as Cell References 173
- 7 Intersection Reference 173
- 8 Relative-Absolute Intersection Reference 174
- 9 Range Reference 175

- 10 Union Operator 175
- 11 Union Operator and Range Reference Similarity 176
- 12 Union Operator and Range Reference Difference 176
- 13 Single Value from a Reference to a Group of Cells 177
- 14 External Relationships between Worksheets 181
- 15 Dependency Diagram 182

Chapter 9 Commands 185

- 16 Results of Copying Vectors 191

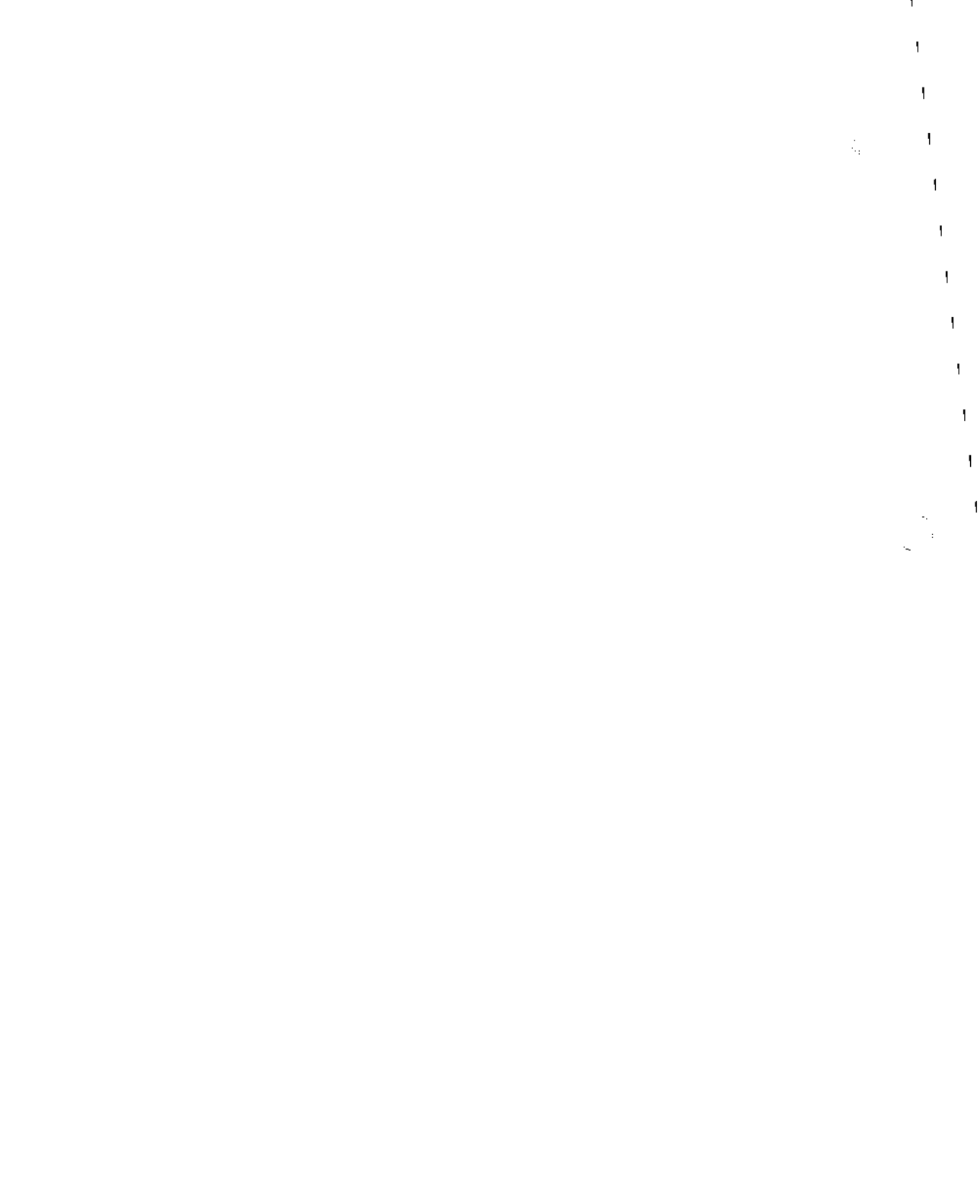

Introduction

Microsoft Multiplan is an electronic worksheet — a large grid of entries, each of which can be words, numbers, or formulas. You can set up the Multiplan worksheet with titles and numbers. But more, Multiplan can replace your pen and paper and your calculator because Multiplan can perform the calculations for you.

Multiplan frees you from the limitations of more traditional methods of calculation. Because Multiplan remembers the relationships between entries on the worksheet, it can automatically perform calculations — and this is where the real power comes from. You get a chance to ask “What if?” to test out plans and to forecast. What if one number changes? What is the effect on the worksheet?

Multiplan lets you alter a critical number and watch the figures change across your worksheet; you can observe the effect over time of a small change here, or an improvement there. You can run sensitivity analyses, do budget and resource planning, and schedule more efficiently. You’ll soon agree that Multiplan is a vast improvement over “hand calculating” methods.

Multiplan overcomes the limitation of paper worksheets. Multiplan offers you a worksheet 4095 rows long and 255 columns wide for words, numbers, and formulas. Multiplan allows you to connect several worksheets so that you can build up a chain of sheets that provide information to each other. You can, as necessary, instantly move, insert, or erase data; widen or shrink columns; or insert or delete space; thereby eliminating the costly and tiresome work of typing or hand printing the worksheet over and over. The Multiplan worksheet is always very flexible.

Multiplan communicates with you as directly and naturally as possible, providing many aids to help you to accomplish your objectives. You will soon learn how to manipulate data to obtain the answers you need.

How to Proceed

An interactive program like Multiplan can be learned only by use. This manual is designed to be read and used as you use Multiplan. It's important that you try, test, and experiment as you learn. You'll be surprised at how quickly it all falls together. Nothing you type can damage the computer or Multiplan, so don't hesitate to experiment.

Part 1, "Using Multiplan," introduces Multiplan in a tutorial manner, in simple steps with many practical examples. You'll learn by using Multiplan to make a financial analysis of a model firm — Spencer Ceramics. The tutorial demonstrates the main Multiplan features as they are commonly used.

Begin by working through Part 1. Chapter 1, "Fundamentals," and Chapter 2, "Building a Worksheet," help you become familiar with the keyboard and screen display and introduce you to the Multiplan typing aids.

"Entering Formulas" and "Naming Cells and Copying," Chapters 3 and 4, lead you further into the use of Multiplan. When you complete these chapters you'll have used some of the most important Multiplan commands and features.

Chapter 5, "Windows, Copying Formulas, and Options," introduces the finer points of the Multiplan screen display. After completing it, you'll be ready to print some samples of your work. Chapter 6, "Printing a Worksheet," tells you how. The final chapter in the tutorial, Chapter 7, "Using Multiple Worksheets," takes you beyond working with a single sheet. You learn how to organize data on multiple sheets and to draw data from them for use on another sheet.

As you work through Part 1, you'll find it helpful to refer to Part 2, "Reference to Multiplan."

Part 2, "Reference to Multiplan," begins with Chapter 8, "Elements of Multiplan," which explains in depth the Multiplan worksheet, how to enter commands, how to edit, what formulas are, how access to files works, and what happens when the worksheet undergoes changes that move data.

Part 2 also contains detailed descriptions of all Multiplan commands in Chapter 9, "Commands," of all mathematical and statistical functions in Chapter 10, "Functions," and of all messages Multiplan displays in Chapter 11, "Messages."

At the end of Part 2, you'll find appendices that contain additional information about advanced features you'll find helpful, including using macros and solving extended problems with the iteration option.

Included also is the Multiplan Quick Reference Guide, which summarizes Multiplan for quick, easy reference.

Begin applying Multiplan to simple tasks, making frequent use of Part 2. As you gain experience, use Multiplan for more complex tasks, such as organizing multiple worksheets. You'll soon find that you have a firm grip on a powerful tool.





Getting Started

This section tells you what you need to know and do before running Multiplan. It covers these topics:

- What You Need
- Installing Multiplan on Your System
- How to Start Multiplan
- The Keyboard

What You Need

To work with Multiplan, you need:

- An 80286 XENIX-based computer with at least 640K bytes of memory
- The XENIX Operating System (version 3.0 or higher), or IBM XENIX 286 Version 2, installed on hard disk
- The Multiplan Program disk
- A printer (optional)

Installing Multiplan on Your System

Multiplan is distributed on a 360K byte, double-sided, 9-sector disk. Before you can use Multiplan, you must run the `msinstall` installation program to copy the Multiplan files from the Multiplan Program disk to the appropriate directories on your hard disk. You need to install Multiplan only once; you can then run Multiplan without re-installing it.

You must have super-user privileges to install Multiplan.

Note When you work through the installation procedure described below, you will need to provide the XENIX device name for your floppy disk drive. On most XENIX-based computers, the drive name is `/dev/fd048ds9`. You should consult the manual for your particular computer to confirm this name. If the floppy disk drive on your computer has a different name, substitute that name in steps 4 and 6 of the following procedure.

Run the `msinstall` program

To install Multiplan:

- 1 Log in on the root account.
- 2 Change your current directory to `/tmp`. At the system prompt, type `cd /tmp`
- 3 Place the Multiplan Program disk in the disk drive (or in drive A, the top or left drive on a two-drive system) and shut the drive door.
- 4 Use the tar command to copy `msinstall` to your hard disk. At the system prompt, type `tar xvf /dev/fd048ds9 msinstall`
- 5 Press the RETURN key to carry out the tar command.
- 6 When the system prompt appears again, type `msinstall -d /dev/fd048ds9 mp`
- 7 Press the RETURN key to run `msinstall`.
The `msinstall` program copies the Multiplan program files to the directory `/usr/bin` and then asks if you have other files to copy.
- 8 When you see the message:

```
Next disk [y, n]?
```

type `n` and press the RETURN key.

- 9 You can now remove `msinstall` from your hard disk. At the system prompt, type `rm msinstall`
- 10 Press the RETURN key.
- 11 Press Ctrl-D to log out from the root account.

Multiplan is now installed on your hard disk. Remove the Multiplan Program disk from the drive and store it in a safe place. If your hard disk is ever damaged or erased, you will need the Program disk.

How to Start Multiplan

After a XENIX super-user has installed Multiplan, any user can start the program.

To start Multiplan:

- 1 Log in on your account.
- 2 When you see the system prompt, type `mp`
- 3 Press the RETURN key.

Now you're ready to work with Multiplan. Turn to Chapter 1 and begin learning about Multiplan. The following section explains the keyboard—refer to it as you work with Multiplan. You don't need to read the "Operating Information" section yet; you'll find it useful after you've gone through the examples in Chapters 1 through 7.

The Keyboard

In Multiplan, some keys have special names. These names describe what the keys do rather than what appears on the key itself. For example, `CANCEL` is the name for a key that lets you stop what you are doing at the moment. Some terminals have a key labeled `Cancel`. On some terminals, you press a key labeled `Esc`. On other terminals, you hold the Control key and press `C`.

Start Multiplan

Standard keys

The chart below lists the standard keys for XENIX Multiplan. This chart is also available within Multiplan with the Help command:

- 1 When the main command menu is on the screen, press H for Help. (When the main command menu is not on the screen, press the HELP key.)
- 2 Press K for Keyboard.
- 3 Scroll through the chart by pressing N to see the next screen and P to see the previous screen.
- 4 To return to Multiplan, press R for Resume.

Important Some keys may differ on your terminal. Look at the keyboard chart with the Help command to see if there are exceptions for your terminal. Note any differences on the chart below and in the Quick Reference Guide.

In the following chart, keys separated by commas represent options available to you. For example, to select the previous item on a menu, you can press either the BACKSPACE key or Ctrl-H. Keys not separated by commas must be pressed in sequence. For example, to move the cell pointer to the previous window, first press Ctrl-R, then press Ctrl-W.

If your terminal has up, down, left, and right arrow keys, they move the cell pointer. If your terminal has a HOME key, it moves the cell pointer to R1C1.

Move the Cell Pointer

Up	Ctrl-E
Down	Ctrl-X
Left	Ctrl-S
Right	Ctrl-D
Previous Window	Ctrl-R Ctrl-W
Next Window	Ctrl-W, ;
Next Unlocked Cell	Ctrl-F, LINEFEED
Previous Unlocked Cell	Ctrl-R Ctrl-F

Scroll the Window

Page Up	Ctrl-R Ctrl-E
Page Down	Ctrl-R Ctrl-X
Page Left	Ctrl-R Ctrl-S
Page Right	Ctrl-R Ctrl-D
Home	Ctrl-Q
End	Ctrl-Z

Select and Execute Commands

Cancel	Ctrl-C
Do this command	RETURN
Select next item on menu	SPACE BAR
Select previous item on menu	BACKSPACE, Ctrl-H
Tab to next field in command	TAB, Ctrl-I
Tab to previous field in command	Ctrl-R, Ctrl-I
Help	?
Recalculate	!
Alternate	Ctrl-A

Edit Cells and Commands

Delete	DELETE, Ctrl-Y
Backspace	BACKSPACE, Ctrl-H
Character Left	Ctrl-K
Character Right	Ctrl-L
Word Left	Ctrl-O
Word Right	Ctrl-P
Reference	@
Edit Macro	Ctrl-V
Single-step through Macro	Ctrl-T



Operating Information

You will find the information in this section useful once you have a feel for Multiplan. It covers the following topics:

- Files and Filenames
- Memory
- Loading Worksheets
- Listing Directory Files
- Specifying a Pathname with Transfer Options
- Printing Multiplan Files
- Starting Multiplan for Mode Conversion
- Multiplan Termcap Entries

Files and Filenames

Computer files, like files of paper documents, are collections of information. This information may be data (numbers, text, formulas, and so on), computer programs, or a combination of the two.

When you run Multiplan, you use the files containing Multiplan programs and data: mp, MP.DAT, and MP.HLP. When you quit Multiplan, Multiplan automatically creates another file, MP.INI, which saves certain setup information in your home directory. See the Quit command in Chapter 9, “Commands,” for more details.

When you build and save a worksheet, you create a new file. This file is a record of the information you put on the worksheet. You name any file you create by filling in the “filename” field of the Transfer Save command.

You can name files as follows:

- Filenames can contain up to 14 characters.
- Filenames can be any combination of letters (A-Z), numbers (0-9), or any other characters except:

/ - ? [] ' ' " "

XENIX does distinguish between lowercase and uppercase characters. For example, *BUDGET*, *Budget*, and *budget* are three distinct filenames.

Memory

As you work with Multiplan, you need to be aware of the distinction between “system memory” and “free space.” System memory is the total amount of memory available on the computer on which Multiplan has been installed. Free space is the portion of system memory provided to individual users for building their worksheets.

Whenever you start Multiplan, the program attempts to give you 512K bytes of system memory to use as your own free space. If 512K bytes of system memory aren't available, XENIX will give you as much free space as it can. However, if the available amount of system memory is less than 32K bytes, Multiplan will abort and the following message will appear on the bottom line of your screen:

```
Insufficient memory available
```

The percentage of free space you have to work with (initially 100%) is displayed on the bottom line of your screen. You will see the percentage gradually decrease as you build your worksheet. Keep in mind, however, that the amount of free space available to you at any time depends on the number of other users working with the total available system memory. This means that the 100% initially allocated to you can represent anywhere from 32 to 512K bytes. Therefore, it may not be possible to load a large worksheet that you built during a previous session if the amount of free space currently available is less than the amount that was available when you first built the worksheet.

Limited memory should only be a problem if use of the system is extremely heavy. You can help conserve system memory, and therefore the amount of free space allocated for your own work, by using the “Hints” suggested throughout this manual. However, if you do have difficulty loading or building worksheets, you should contact your system administrator.

System memory

Free space

Loading Worksheets

All Multiplan worksheets that you create, as well as those created by other users, are stored in the XENIX file system, which is made up of various “directories.”

Multiplan allows you to work in one directory and load (or save, clear, etc.) worksheets from another of your directories. With the proper permissions, you can also access worksheets in another user’s directory.

Any Multiplan file (worksheet) that you want to work with will be located in either:

- Your current directory (the home directory you log in to or one you’ve changed to)
- Some other directory (belonging either to you or to another user)

When you log in to the system, XENIX automatically places you in your home directory. If the worksheet you want is in this directory, you need only to start Multiplan (as described in “Getting Started”), and then use the Transfer Load command to bring the worksheet up on your screen.

Any time that you want to load a worksheet that is not in your current directory, you must specify the pathname to the worksheet’s location. The pathname you specify is the “map” Multiplan uses to find the worksheet you want.

The following example shows how to load a worksheet named *june1985*. The worksheet is in the directory *budget* belonging to a user whose home directory is *joe*.

- 1 Start Multiplan (as described in “Getting Started”).
- 2 Choose the Transfer Load command.
- 3 In the “filename” field, type */usr/joe/budget/june1985*
- 4 Press the RETURN key.

You can read a worksheet in another user’s directory, provided the user hasn’t read-protected the worksheet; you can modify the worksheet, provided the user hasn’t write-protected it.

If the worksheet is read-protected, you’ll see the following message when you try to load the worksheet:

```
Cannot read file
```

Loading worksheets in your home directory

Loading worksheets in other directories

This message tells you that the permissions on the worksheet will have to be changed before you can load it.

If the worksheet is write-protected, or if another user is currently working on the worksheet, you'll see the following message when you try to save the file:

Cannot write file

This message tells you that you cannot save any changes you've made to the worksheet unless you either:

- Save the worksheet under a different name
- Save the worksheet in a different directory

When you do either of the above, you create a copy of the worksheet (including any modifications that you've made) under the name or in the directory that you specify. The original worksheet is not affected in any way (that is, it's left in the same condition, in the same directory, and with the same name as when you loaded it).

If you want to exchange a worksheet with another version of Multiplan (for example, MS-DOS Multiplan), you must save the worksheet in Symbolic Link (SYLK) format. To do so, first change the response in the "mode" field of the Transfer Options command from Normal to Symbolic. Then use the Transfer Save command to save the worksheet. Before loading the worksheet into the other version of Multiplan, make sure that you again choose Symbolic in the "mode" field of the Transfer Options command.

Exchanging worksheets with other versions of Multiplan

Listing Directory Files

Frequently, you may need to review a list of filenames in a directory before loading the worksheet you want. To do so:

- 1 Change to the directory containing the worksheet you want.
- 2 Start Multiplan.
- 3 Choose the Transfer Load command.
- 4 Press the RIGHT key.

A list of all files contained in the directory will appear on the screen.

List directory files

Specifying a Pathname with Transfer Options

Whenever you start Multiplan, the program places you in the directory whose pathname you specified in the “setup” field of the Transfer Options command. Usually, your response in this field will be the pathname of the directory you normally work in.

On occasion, however, you may want to work regularly for a while in a different directory. For example, you may need to maintain the worksheets of another user who has gone on vacation. In such cases, it's a good idea to change the response in the “setup” field to the pathname of the directory in which you'll temporarily be working. Once you have done so, you will not have to use the XENIX change directory command each time before starting Multiplan. Instead, Multiplan will automatically place you in the directory you want.

When you've finished working in the directory (for example, when the user whose worksheets you maintained returns from vacation), remember to change the response in the “setup” field back to the pathname of the directory you normally work in.

Note For complete instructions on working with the XENIX file system, see your *XENIX Operations Guide*.

Printing Multiplan Files

Multiplan works well with a variety of printers. (The printer should expect ASCII characters, a carriage return, and a linefeed, in that order, at the end of each line). Multiplan can send any special characters the printer needs to set print modes, such as bold-face or 160-character width. Your printer manual will tell you what print modes are possible and what special characters to send to set the modes. To send special characters from Multiplan:

- 1 From the main command menu, press P, then O.
This puts you in the Print Options command.
- 2 Press the TAB key.
This puts you in the “setup” field.
- 3 Type the special characters.

Send special characters

To send a control character, press the ^ key, then the uppercase character; for example, for CONTROL-L type `^L`. To send an escape character, type ^ [followed by the uppercase character; for example, for ESC-U type `^[U`. (If you prefer to specify these special characters in hexadecimal notation, Multiplan will accept `&HXX`, where `XX` is the hex value of the characters. For example, ESC-U could be coded as `&H1BU`.)

- 4 Press the RETURN key.
You are now back at the Print command.
- 5 Choose the Printer command and press the RETURN key.

Multiplan sends the special characters to the printer when it begins printing a worksheet.

Multiplan saves the setup field of the Print Options command when you save the worksheet. This means you won't have to re-enter the special characters each time you want to print the worksheet. You can change the setup field any time you want to change the print modes for the worksheet. If you choose File instead of Printer, Multiplan includes the special characters in the printable file.

Starting Multiplan for Mode Conversion

You can also start Multiplan with the names of worksheet files you want loaded at the same time by typing a command like this:

```
mp filename1 filename2 filename3 ...
```

If you give only one filename after *mp*, the computer loads Multiplan, and Multiplan loads the worksheet file in Normal mode.

If you give more than one worksheet name when you start, Multiplan assumes that the first worksheet is stored in Symbolic mode and that you want to convert it to Normal mode before loading it. For information on worksheet modes, see the Transfer Options command in Chapter 9, "Commands."

For example, if you type *mp SKBUDGET BUDGET*, Multiplan will look for the worksheet SKBUDGET that you previously saved in Symbolic mode. Then, it will convert the worksheet to Normal mode, name the new worksheet BUDGET, and Transfer Load that worksheet so you can work on it. Here are a couple of points to keep in mind:

- You now have two copies of the same file stored on the disk: SKBUDGET (in Symbolic mode) and BUDGET (in Normal mode). Unless you Transfer Save any changes you make in *both* Symbolic and Normal mode, the Symbolic and Normal versions of your worksheet on the disk will be different. If you want them to be identical, Transfer Save your worksheet twice—once in Symbolic and once in Normal mode.
- If you already have a worksheet named BUDGET stored on the disk and you type *mp SKBUDGET BUDGET*, Multiplan will ask you if you want to replace the existing BUDGET with the one converted from SKBUDGET. Press Y if you do, N if you don't.

If you give more than two worksheet names, Multiplan processes the names in pairs. It takes the first name of each pair, converts the worksheet file with that name from Symbolic to Normal mode, then gives the second name of the pair to the Normal mode version. When Multiplan finishes converting the worksheets, it loads the last worksheet on the list so you can work on it. If you give an odd number of filenames, Multiplan loads the last one as a Normal file.

Multiplan Termcap Entries

The XENIX *termcap* file defines the capabilities of the terminals supported by Multiplan. For example, Multiplan uses the *termcap* file to perform such standard operations as clearing the screen and positioning the cursor.

The following table lists the two-letter codes for terminal capabilities that are used by Multiplan. You will need to be familiar with these codes if you wish to either:

- Modify any existing termcap entry
- Add a terminal currently not supported by Multiplan

For information on editing the *termcap* file, see the discussion under **TERMCAP(M)** in your *XENIX Command Reference* manual. You must have super-user privileges to edit the *termcap* file.

Name	Description
AL	Sent by ALTERNATE key
bc	Backspace if not ^H
BE	Bell character
bs	Terminal can backspace with ^H
BS	Sent by BACKSPACE key (if not bc)
cl	Clear screen
CL	Sent by CHAR LEFT key
CN	Sent by CANCEL key
co	Number of columns in a line
CR	Sent by CHAR RIGHT key
CW	Sent by CHANGE WINDOW key
DK	Sent by down arrow key (if not kd)
DL	Sent by DELETE key
do	Down one line
EM	Sent by EDIT MACRO key
EN	Sent by END key
EX	Sent by EXTEND SELECT key
G1	Upper-right (1st quadrant) corner character
G2	Upper-left (2nd quadrant) corner character
G3	Lower-left (3rd quadrant) corner character
G4	Lower-right (4th quadrant) corner character
GD	Down-tick character
GE	Graphics mode end
GH	Horizontal bar character
GS	Graphics mode start
GV	Vertical bar character
HM	Sent by HOME key (if not kh)
ho	Home cursor (if not cm)
HP	Sent by HELP key
HW	Sent by HOME WINDOW key
li	Number of lines on screen or page
LK	Sent by left arrow key (if not kl)

Name Description

MP	Multiplan initialization string
MR	Multiplan reset string
nd	Non-destructive space (cursor right)
NU	Sent by NEXT UNLOCKED CELL key
PC	Sent by PREVIOUS UNLOCKED CELL key
PD	Sent by PAGE DOWN key
PF	Sent by PREVIOUS FIELD key
PL	Sent by PAGE LEFT key
PR	Sent by PAGE RIGHT key
PU	Sent by PAGE UP key
PW	Sent by PREVIOUS WINDOW key
RC	Sent by RECALC key
RF	Sent by TOGGLE REFERENCE key
RK	Sent by right arrow key (if not kr)
RT	Sent by RETURN key
ST	Sent by SINGLE STEP THROUGH MACRO key
TB	Sent by TAB key
UK	Sent by up arrow key (if not ku)
up	Upline (cursor up)
WL	Sent by WORD LEFT key
WR	Sent by WORD RIGHT key



Using Multiplan

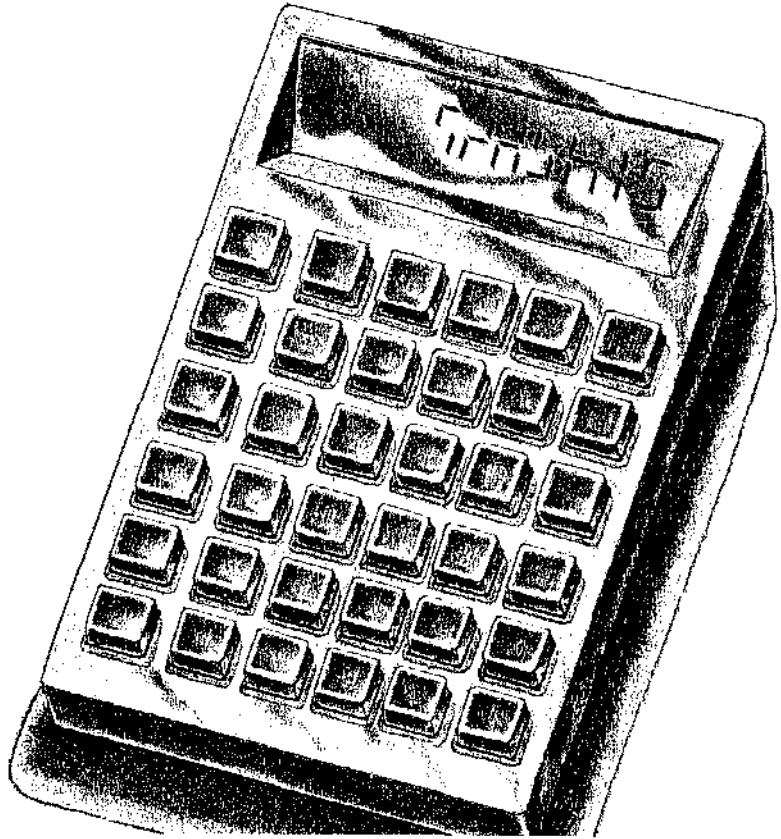

Using Multiplan

The chapters in this part will teach you about:

1. Fundamentals
2. Building a Worksheet
3. Entering Formulas
4. Naming Cells and Copying
5. Windows, Copying Formulas, and Options
6. Printing a Worksheet
7. Using Multiple Worksheets

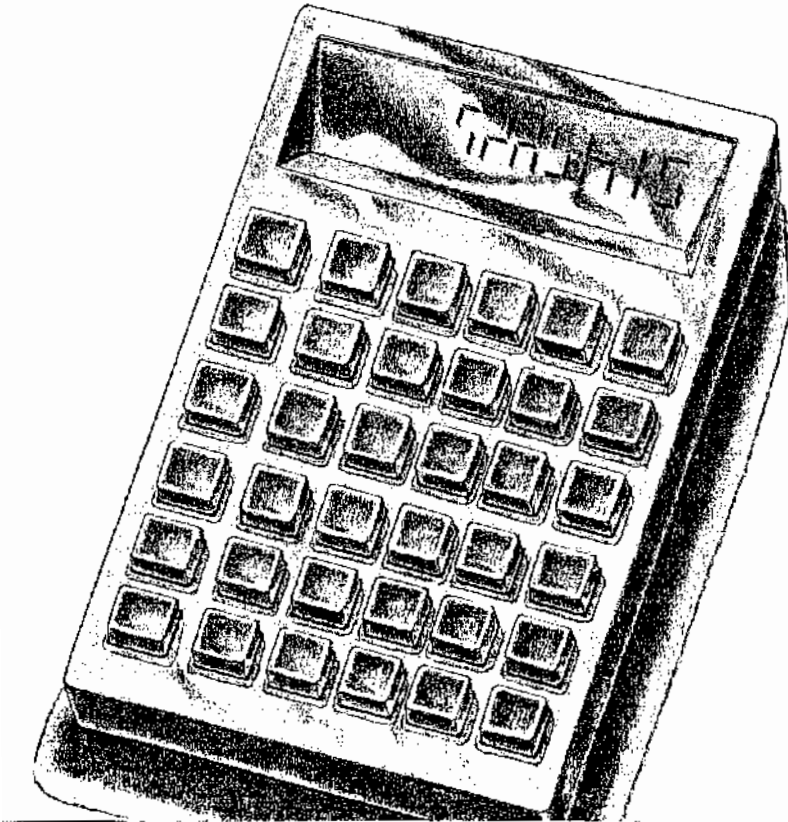

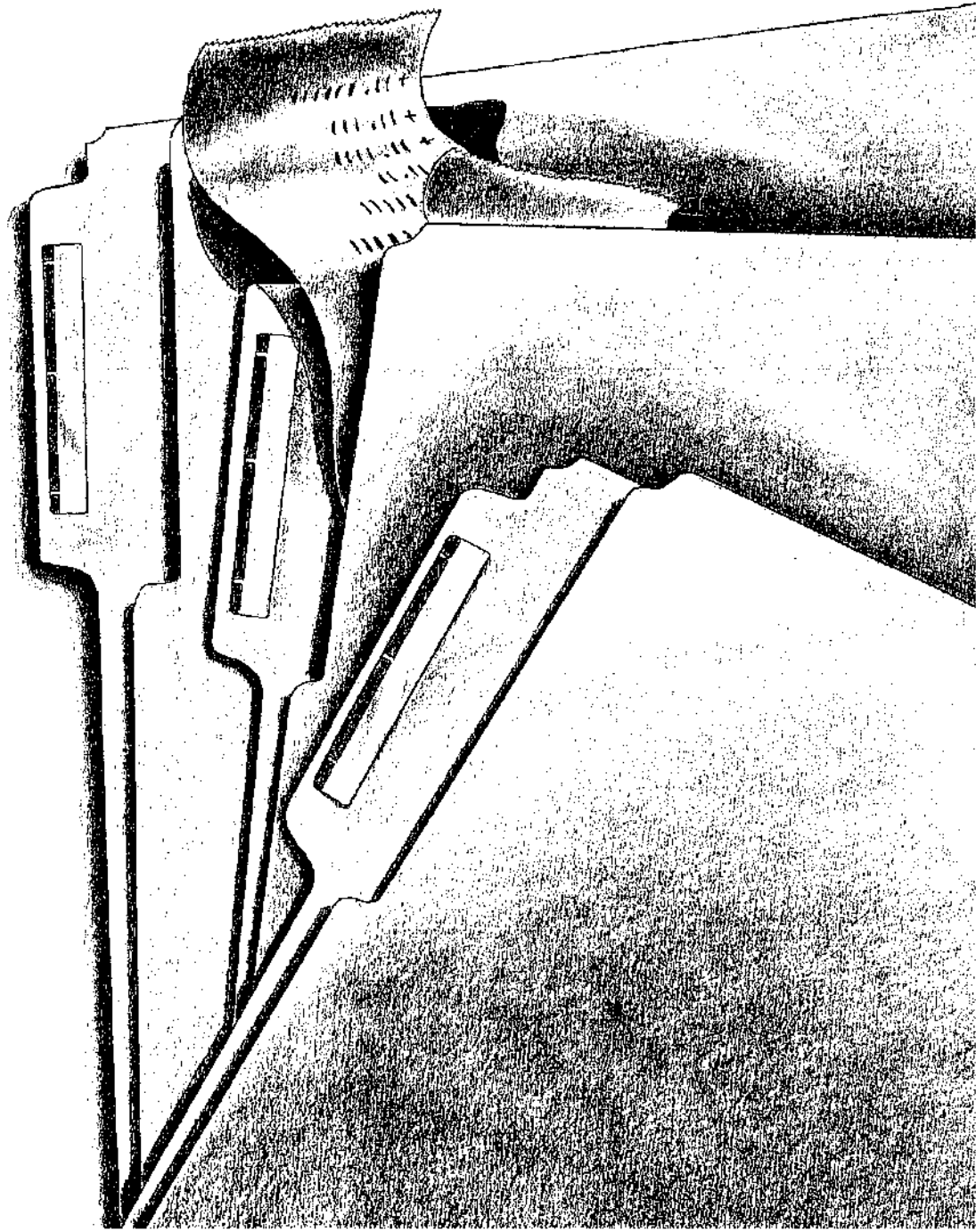

lec
Q11

What you see now is the basic Multiplan screen. Notice the row and column numbers, command line, message line, and status line, as well as three highlighted areas for window number, cell pointer, and command menu. You'll learn more about the parts as you progress through this manual.

Your screen displays only a small portion of the actual worksheet available to you. You can imagine the screen as a window to your worksheet:

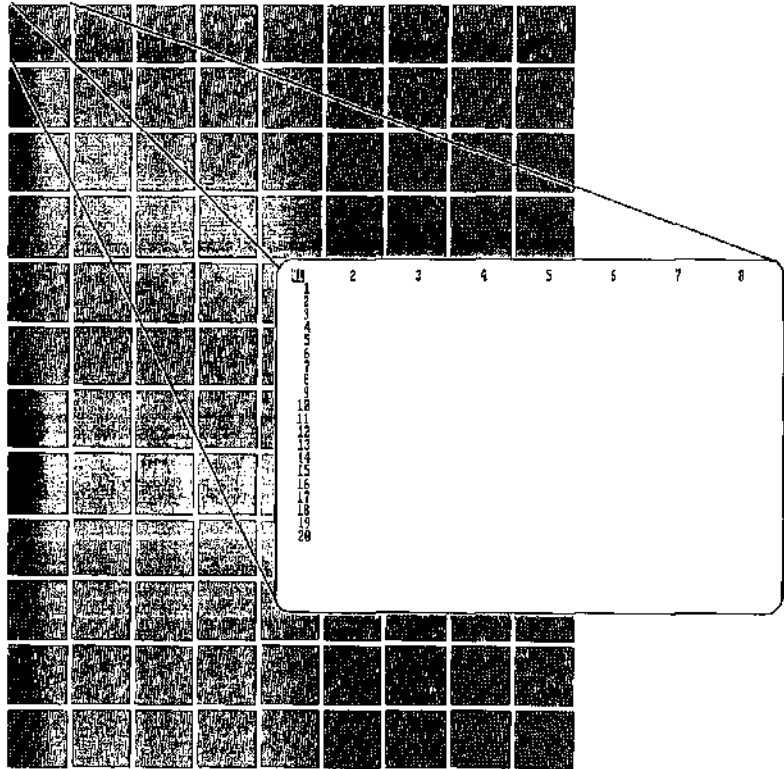

With Multiplan, it is possible to see information on different parts of the worksheet by viewing the sheet through more than one window at a time. You will learn how to do that in Chapter 5, "Windows, Copying Formulas, and Options."

Columns are numbered across the top. The illustrated screen now shows you 7 of the 255 worksheet columns.

Rows are numbered down the left side of the display. The illustrated screen now shows you 20 of the 4095 worksheet rows.

Imagine lines running vertically between the column numbers and horizontally between the row numbers to form boxes on the worksheet. Each box is called a "cell." Cells hold the values of the worksheet.

The cell that is available for immediate use, the active cell, is illuminated by the cell pointer. The cell pointer is currently in the upper left corner of the display; in row 1, column 1. A cell is identified by its location; the row number is always given first. Cell "row 1, column 1" (R1C1) is the active cell now.

Cell numbering

The Direction Keys

The direction keys

Look at the Quick Reference Guide that came with Multiplan to find the direction keys (named UP, DOWN, LEFT, and RIGHT). Then, locate the keys on your keyboard. These keys are used to move the cell pointer around the worksheet (and for other functions you will learn about later).

Move the cell pointer

Moving the Cell Pointer

Press the RIGHT direction key once. Now look at the cell pointer. You moved it one cell to the right, to column 2. The pointer is now in row 1, column 2 (R1C2). That cell is now the active cell.

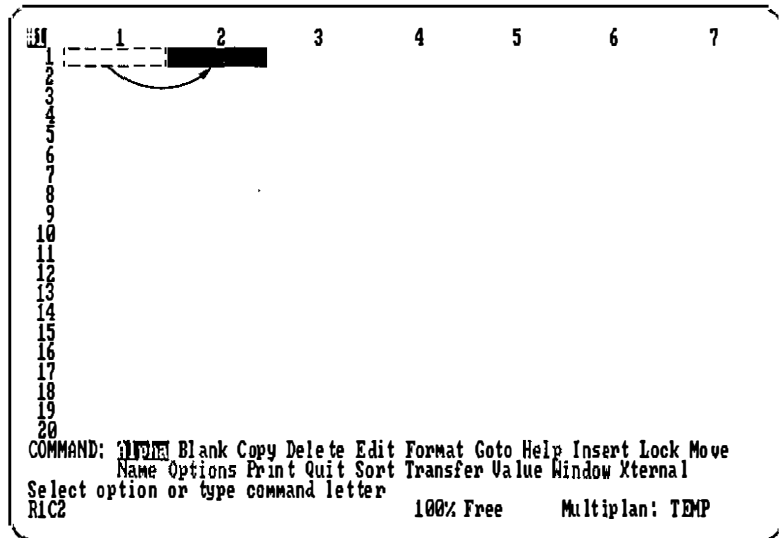

Try the other direction keys. Watch how the cell pointer moves. Try to move the cell pointer to row 4, column 4 (R4C4). You can press the direction keys in any order you want.

The Status Line

The status line

The bottom line of the screen is called the status line. It tells you the location of the active cell and what it contains. Right now the status line should read R4C4, which is a location. If any other location is shown, use the direction keys to move the cell pointer to row 4, column 4. The space next to R4C4 in the status line shows the contents of the cell; right now the cell is blank so the space is empty.

```

 1  2  3  4  5  6  7  8
 2
 3
 4      █
 5
 6
 7
 8
 9
10
11
12
13
14
15
16
17
18
19
20
COMMAND: █ █ █ █ Blank Copy Delete Edit Format Goto Help Insert Lock Move
          Name Options Print Quit Sort Transfer Value Window Xternal
Select option or type command letter
R4C4                                     100% Free      Multiplan: TEMP

```

Status line: shows active cell row 4 column 4

Look at the percent in the center of the status line. It tells you how much working memory is left.

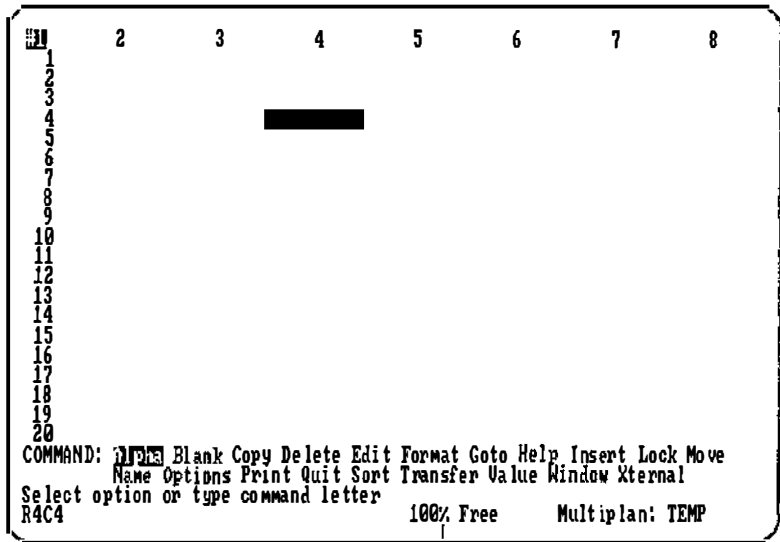

| Storage space remaining

“100% Free” means that all of the working memory is available for your use. Check this percent as you continue your work. The number shows how much room is left to continue your work.

You can name worksheets for ready reference. The status line will also tell you the name of the worksheet currently in use. Until you give your sheet a name of your own, Multiplan calls it *TEMP* (for temporary).

1	2	3	4	5	6	7	8
1							
2							
3							
4							
5							
6							
7							
8							
9							
10							
11							
12							
13							
14							
15							
16							
17							
18							
19							
20							

COMMAND: **FILE** Blank Copy Delete Edit Format Goto Help Insert Lock Move
 Name Options Print Quit Sort Transfer Value Window Xternal
 Select option or type command letter
 R4C4 100% Free Multiplan: TEMP

Name of worksheet |

Scroll the worksheet

Scrolling the Worksheet

The illustrated screen shows you only 7 columns. What if you want to see column 15? Press the RIGHT direction key until the cell pointer reaches the right edge of the display. As you continue to press the RIGHT direction key, the pointer remains still, but the columns move to the left beneath it. This is called scrolling. Press the RIGHT direction key until column 15 is reached. (Columns 1 through 8 are no longer visible on the left.) You are now in row 4, column 15 (R4C15).

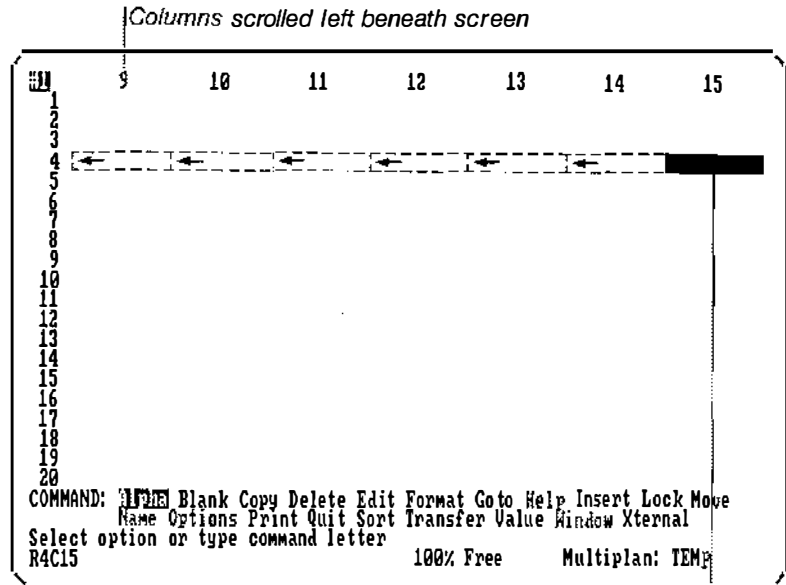

Now press the DOWN direction key until the cell pointer reaches row 43. You are now in row 43, column 15 (R43C15).

Rows scroll up beneath screen

24	9	10	11	12	13	14	15
25							
26							
27							
28							
29							
30							
31							
32							
33							
34							
35							
36							
37							
38							
39							
40							
41							
42							
43							

COMMAND: **FILE** Blank Copy Delete Edit Format Goto Help Insert Lock Move
 Name Options Print Quit Sort Transfer Value Window Xternal
 Select option or type command letter
 R43C15 100% Free Multiplan: TEMP

Pointer stays on screen

Notice that during all of these movements, the cell pointer always stays on the screen. When the cell pointer reaches the edge of the display, the row numbers or the column numbers scroll across the screen. You could visualize this as sliding the window around the worksheet.

You could return to the upper left corner of the worksheet (R1C1) by pressing the UP and LEFT direction keys until the cell pointer arrives there. But there is another, faster way to move the cell pointer to R1C1.

Look at the Quick Reference Guide again. Find the HOME key and try it. The cell pointer returns in one movement to the upper left corner (R1C1).

Hint Use the PAGE, HOME, and END keys to scroll rapidly across and down the worksheet.

The Goto command

The Goto (G) Command

There is a way that is faster than using the direction keys to reach a cell on a different part of the worksheet. Press the G key. At the bottom of the screen on the command line (above the status line and message line), you should see the command:

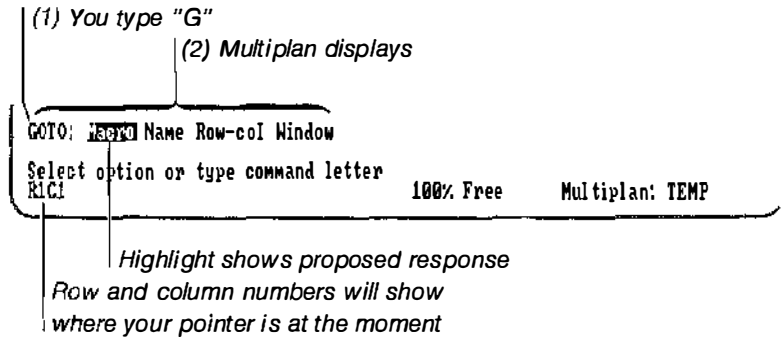

You can see that the Goto command now offers you a choice of subcommands: Macro, Name, Row-col(umn), or Window. (Macro will be discussed in Appendix A, "Macros"; Names in Chapter 4, "Naming Cells and Copying"; Windows in Chapter 5, "Windows, Copying Formulas, and Options.") For now, we'll consider the Row-col subcommand.

Look at the illuminated box on the command line. It shows which command is selected on a menu.

If you now press R, you will see:

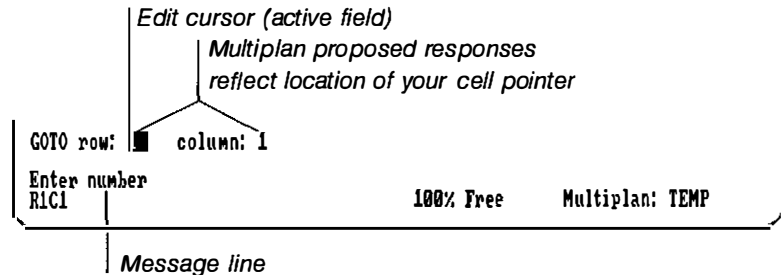

Multiplan is also displaying numbers in the command line in this example, one number by "row" and one number by "column." The words *row* and *column* are the names of command "fields,"

Command Selection from Menus

All Multiplan commands are selected as the Goto command was: you first select the initial letter of the command you want, then you choose one of several versions of the command (subcommands) with another letter.

Note If you pressed a key that does not work as a command (an invalid command), such as the letter J, the command line will not change, but you will see the message “Not a valid option.”

```

      | Edit cursor does not move
      |
COMMAND: NBlank Copy Delete Edit Format Goto Help Insert Lock Move
          Name Options Print Quit Sort Transfer Value Window Xternal
Not a valid option
R155C3                                99% Free      Multiplan: TEMP
  
```

If you have pressed other keys while you were moving the cell pointer, or if you pressed the wrong command letter, look at your Quick Reference Guide to find the CANCEL key. Press it to clear the command line.

The lists of commands (or subcommands) are called menus. In fact, any time you see choices on the command line, that's a menu. You can select an option from a menu, as the message in the message line will tell you to do (“Select option”), by typing the first letter of the option you want.

There's another way to select commands and other options. Press the SPACE bar and watch the command line. The highlight moves left to right, stopping at each command name.

Press the SPACE bar until Goto is highlighted. Now press RETURN. The command line should look the same as it did when you typed G earlier.

Similarly, you can press SPACE to move between “Name,” “Row-col,” and “Window.” When the highlight rests on “Row-col,” press RETURN and you'll see the “row” and “column” fields, as before.

BACKSPACE can be used to back up (move right to left) through a menu.

To save you time, Multiplan presents the subcommands in the order you are most likely to use them. If several subcommands are equally as likely to be used, they are presented in alphabetical order.

Select from a menu

You continue to select subcommands until the command line shows command fields. Command fields tell Multiplan how to perform the command.

Proposed responses

Multiplan Proposed Responses

When the command line shows fields (for the Goto Row-col command the fields were “row” and “column”), each field will show a proposed response. In some fields, the proposed response is a blank. In some fields, a proposed response is given which looks like a typed-in response. In fields that have a menu of possible responses, the proposed response is shown either by the highlight (when the edit cursor is in that field) or by parentheses (when the edit cursor is in another field).

Proposed responses often reflect the current settings, positions, and name of the worksheet that you are working with. If you agree with the proposed response, merely press the RETURN key to carry out the command or press TAB to move to the next command field. If you do not want the proposed response, you can change the command field to the response you want.

When you are selecting a command or subcommand, the first choice shown is highlighted. This is also called a proposed response. If you agree with the proposed response, merely press the RETURN key. Or, press SPACE or BACKSPACE to move to another choice. The command line will change to display your choice.

The TAB key

Filling in the Command Line: The TAB Key

The command line will be divided into as many fields as there are choices to be made. The edit cursor shows you which field is active (available for immediate use).

The edit cursor is moved from field to field by the TAB key, and will return to the first field after the last field has been reached.

In commands with more than two fields, the TAB key moves the cursor like this:

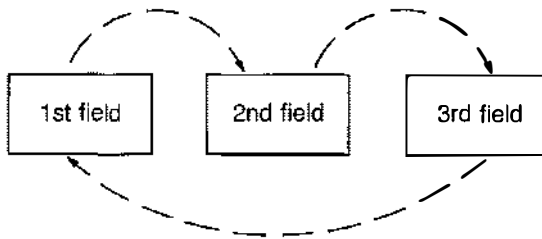

The **BACKTAB** key moves the cursor to the previous field.

Look at the message line below the command line. Multiplan tells what kind of response you should make in each field. As you move from field to field, the message may change. For the Goto Row-col command it doesn't because both fields require the same type of response, but the message will change for other commands, as we'll see later.

Carrying Out a Command: The RETURN Key

The RETURN key

Multiplan does not carry out the command until you tell it to do so. The **RETURN** key is used to carry out commands.

Also, as shown earlier, the **RETURN** key is used after you use **SPACE** or **BACKSPACE** to move the highlight to a command or subcommand name.

You can press the **RETURN** key whenever the responses in all the command fields are correct; you are not required to move the edit cursor first.

When a command has been carried out, the command line reappears and waits for a new command from you.

Canceling a Command: The CANCEL Key

The CANCEL key

At any time before you press **RETURN** to carry out a command, you may press the **CANCEL** key to cancel the command. When you press the **CANCEL** key, the main command menu will reappear and the worksheet will appear as it did before you began the command.

The Help command

The Help (H) Command

Microsoft Multiplan includes a special Help command to assist you while using Multiplan.

The help information is always available to you.

Let's use the Goto command to illustrate how the Help command works.

Select the Goto command by using SPACE; do not press RETURN. When the highlight rests on Goto, press the ? key. The Multiplan worksheet will be replaced by the help information for the Goto command.

GOTO

Used to move cell pointer over sheet.

GOTO MACRO

Moves the cell pointer directly to upper left corner of named macro and begins executing the macro. The direction keys may be used to step through the directory of names.

GOTO NAME

Moves cell pointer directly to the upper left corner of named area.

GOTO ROW-COL

Moves cell pointer directly to specified row and column. If cell requested is already visible, window is not moved. Otherwise window is shifted to the specified cell.

As you can see, the information given for "GOTO ROW-COL" describes what happened when you used the Goto Row-col command.

Notice also that there is a new menu in the command line that looks like:

```
HELP: RESUME Start Next Previous
      Applications Commands Editing Formulas Keyboard
Select option or type command letter
R155C3                               100% Free      Multiplan: TEMP
```

These subcommands are used to view various parts of the help information.

For right now, press C (for Commands). The Goto information is replaced by the beginning of the COMMAND OVERVIEW, which describes how to select commands, as described earlier.

Now, press N (for Next). The rest of the COMMAND OVERVIEW is shown. You will often need to use the N subcommand because the information for many topics is longer than one screenful.

Now, press R (for Resume). The Multiplan worksheet display resumes exactly as you left it; no changes were made. As you can see, the Goto command is still highlighted.

If you try out the Help command, you'll begin to see how it adapts the information to your situation. Let's take Goto again.

Select Goto (if you use SPACE to do this, press RETURN). With the "Name" subcommand highlighted, press ?.

Now the screen shows only part of the Goto information, with GOTO NAME at the top.

Press R (for Resume). Move the highlight to Row-col and press ?. Now GOTO ROW-COL is at the top.

Whenever you request help information with the ? key, the information describing the command or subcommand you have selected is listed at the top of the screen.

Instead of the ? key, you can also use the Help command. (First, you need to return to the main command menu—press CANCEL.) When the main command menu is on display, press H. Multiplan replaces the worksheet display with the beginning of the Help information.

Now, you can use the Help subcommands in the menu to move through the help information.

From now on, whenever you need quick assistance, you know you can get help by pressing the ? key or by using the Help command.

One final bit of help: remember looking at your Quick Reference Guide earlier for some of the keys? Select the Help command then press K (for Keyboard). The beginning of the list of keys appears. Use "Next" (press N) to view the rest of the list.

The Quit (Q) Command

The Quit command

In your next Multiplan lesson, you will learn how to place information on the worksheet. To leave Multiplan now, however, use the Quit command. Press Q. Your screen will show:

QUIT:

Enter Y to save edits, N to lose edits, or cancel ■
R155C3 100% Free

Multiplan: TEMP

The command line asks you whether you want to save or lose your changes. Press N.

After you've learned to place information on the worksheet, you'll learn how to save your work before you use the Quit command.

When you quit, Multiplan automatically saves the status of certain command fields in a file named MP.INI. You will learn more about these command fields in later chapters. You can learn more about the MP.INI file in the Quit command in Chapter 9, "Commands."

The screen is now blank.

Summary

Summary

In this session you learned:

- What the different parts of the screen look like and what they mean.
- Where the the direction keys are located on the keyboard, and what they do.
- How to move the cell pointer using the direction keys and HOME key.
- Where the status line is located, and what it tells you.
- How to scroll the worksheet by using the direction keys.
- How to get to another cell quickly by using the Goto (G) command.
- How commands are structured.
- How Multiplan helps you by presenting proposed responses.
- How to move the edit cursor between fields by using the TAB key.
- How to carry out a command by using the RETURN key.
- How to leave Multiplan by using the Quit (Q) command.
- How to request help by using the ? key and the Help (H) command.

2 Building a Worksheet

In Chapter 1, you learned how to start Multiplan and how the rows and columns are used to identify the cells of the worksheet.

You also learned how to move the cell pointer to different parts of the worksheet by using the direction keys, and how to move the pointer quickly by using the Goto command.

In this session you will begin to build a worksheet. You will learn how to change cell entries and correct mistakes as you go along. You will also begin work on a financial analysis for a model company—Spencer Ceramics.

A large industrial firm is considering buying Spencer Ceramics and has requested a projected income statement; the firm has asked you for a summary operating budget, showing projected sales, costs, and gross profits. If, on the basis of this information, Spencer Ceramics looks like a good investment, the firm will send in its own accountants to do a more detailed survey.

The worksheet number grid

The Worksheet Number Grid

Load the Multiplan diskette according to the instructions given in the Multiplan Quick Reference Guide. In a moment you will see the row and column numbers, as well as the command, message, and status lines appear on the screen.

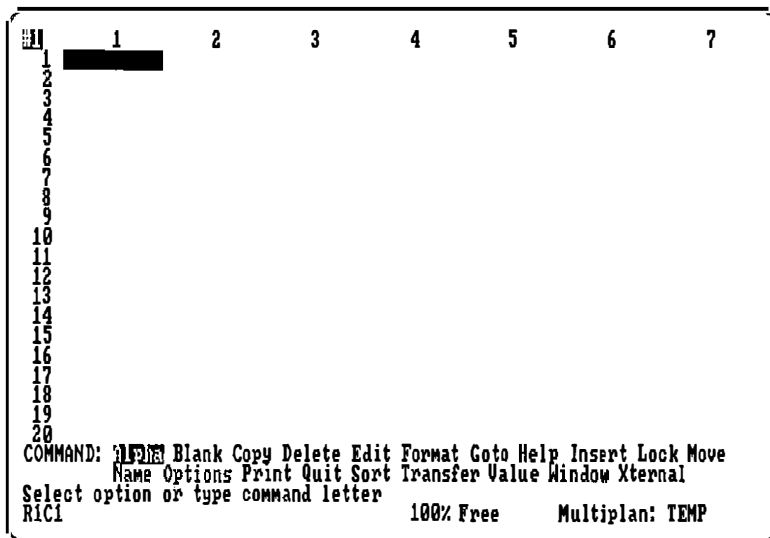

The row and column numbers are merely guides for entering data. The information on the command, message, and status lines is there only to help you enter the data on the worksheet and will not appear on the final printed form.

To plan what needs to be done in your analysis of Spencer Ceramics, let's sketch a brief outline with pencil and paper, showing how the table will be set up.

Spencer Ceramics Projected Income Statement Units per year - 12														
	Jan.	Feb.	Mar.	Apr.	May	Jun.	July	Aug.	Sept.	Oct.	Nov.	Dec.	Jan.	Sum.
Sales														
Cost														
Profit														

With Multiplan, it is easy to expand the worksheet later to add more items, to insert rows or columns of space, or to delete unwanted items. It is even easy to change a figure, such as January sales; Multiplan will recalculate the entire table automatically.

Entering Text: The Alpha (A) Command

To prepare the worksheet for Spencer Ceramics, begin by entering the headings for the rows and columns. You can add a title to the sheet later.

Text and numbers are entered in different ways. Since Multiplan is designed to deal primarily with numbers and formulas, it automatically recognizes numbers as soon as they are typed. However, when you want to enter text or a title, you must specifically tell Multiplan that you want to enter text, and not

Enter text

a formula, into the cell. You do this by using the Alpha (A) command.

Before you begin, look at the cell pointer on your screen. It should be in row 1, column 1 (R1C1). If it is not, use the direction keys or the HOME key to place it there.

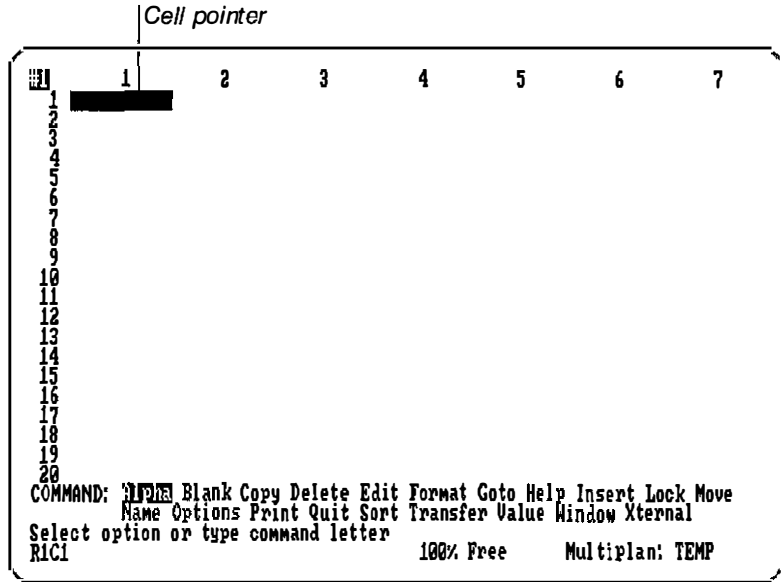

Since you will later need some room at the top of your table for the names of the months, move the cell pointer down two rows. The pointer is now in row 3, column 1 (R3C1).

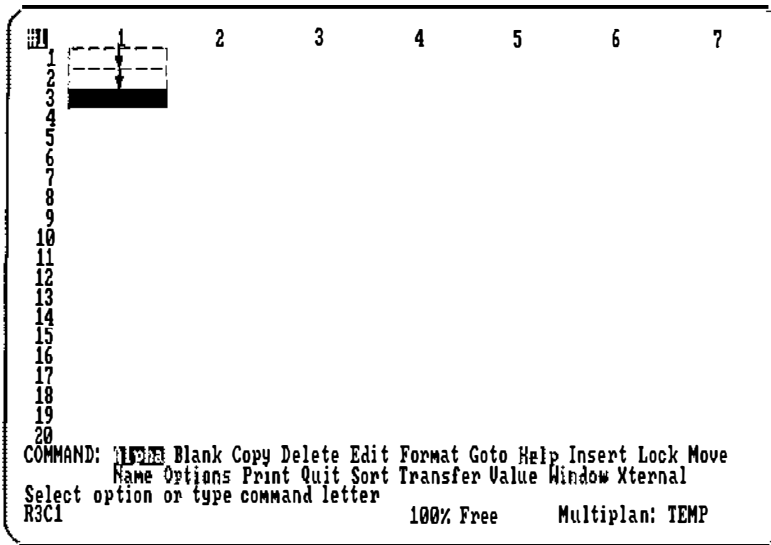

Now press A. You will see:

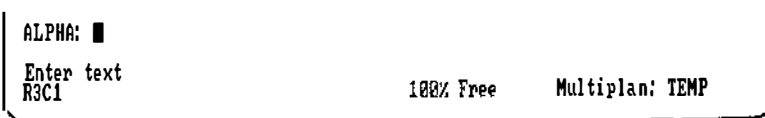

The command line indicates selection of the Alpha command, and the message line informs you that the next step is to enter text. Begin by entering Sales in column 1.

Type *Sales*.

Now you see:

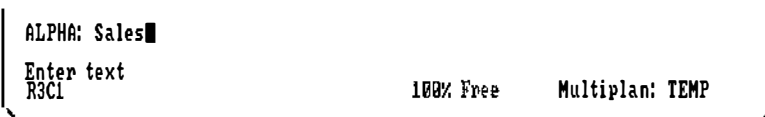

Correcting Typing Errors: The BACKSPACE Key

Correct typing errors

The edit cursor is located immediately after the text you have typed. Before you press RETURN to enter the text in the cell, try editing the word *Sales* by using the BACKSPACE key. Press BACKSPACE three times. You will see that the edit cursor deletes the character to its left as it moves. You now have:

BACKSPACE deletes as it moves

```
ALPHA: Sa█
Enter text
R3C1                100% Free    Multiplan: TEMP
```

This time type the word incorrectly. Finish typing *Sakes*. Notice that the new characters appear just to the left of the edit cursor. When you've finished typing, you have:

```
ALPHA: Sakes█
Enter text
R3C1                100% Free    Multiplan: TEMP
```

Now use BACKSPACE again and correct the text to *Sales* once again, so that the screen looks like:

```
ALPHA: Sales█
Enter text
R3C1                100% Free    Multiplan: TEMP
```

Entering Data with the Direction Keys

Now that the word *Sales* is correct, you can enter it into the cell in two ways:

- 1 You could first press RETURN, and *Sales* would appear in the cell R3C1. Try it to see. You now need to press a direction key to move the pointer to the next cell. Before you press a direction key, consider the second way to enter data.
- 2 A faster way to enter text is to press the DOWN direction key (instead of RETURN), moving the pointer to the next cell in which you want to work. *Sales* will be entered automatically. Try it. Press A (for Alpha); *Sales* now appears next to ALPHA: in the command line. Now press the DOWN direction key. *Sales* reappears in cell R3C1, and the cell pointer moves down to R4C1. (You may, of course, use any direction key; your choice will depend on the cell you want to use next.) Notice the command line; it shows:

ALPHA/VALUE: █

Enter text or value
R4C1

99% Free

Multiplan: TEMP

The next key you press selects either the Alpha command or the Value command, just as if you pressed A or V.

If you type any digit, 0-9, or press one of the characters = (equals), + (plus), - (minus), . (period), ((left parenthesis), or " (quotation mark), you select the value command. All other keys select the Alpha command.

This feature will save you many keystrokes as you continue to work with Multiplan, especially when entering a sequence of text and values in successive cells.

To enter *Cost*, move the cell pointer down to row 5 in column 1 (R5C1).

Enter your data

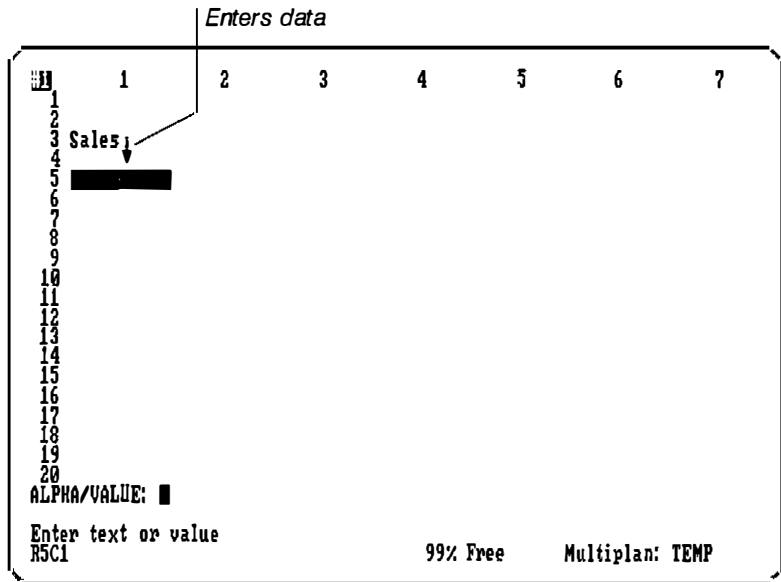

Multiplan is waiting for your next instruction. Tell it that you want to enter more text by beginning to type *Cost*. As soon as you press C, the command line changes from ALPHA/VALUE: to ALPHA:, and the message line changes from "Enter text or value" to "Enter text."

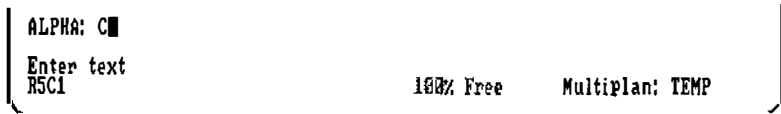

Finish typing *Cost*.

To enter *Cost* in row 5, column 1 (R5C1), press the DOWN direction key. Continue to press the DOWN direction key until the screen looks like this:

	1	2	3	4	5	6	7
1							
2							
3	Sales						
4							
5	Cost						
6							
7							
8							
9							
10							
11							
12							
13							
14							
15							
16							
17							
18							
19							
20							

ALPHA/VALUE: █

Enter text or value
R8C1

99% Free Multiplan: TEMP

Now enter *Gross Profits* in cell R8C1 (your current position).

Column too narrow

	1	2	3	4	5	6	7
1							
2							
3	Sales						
4							
5	Cost						
6							
7							
8	Gross Profits						
9							
10							
11							
12							
13							
14							
15							
16							
17							
18							
19							
20							

COMMAND: █ █ █ █ Blank Copy Delete Edit Format Goto Help Insert Lock Move
Name Options Print Quit Sort Transfer Value Window Xternal
Select option or type command letter

R8C1 "Gross Profits" 99% Free Multiplan: TEMP

Column Width

Change column width

You can see that the column is not wide enough to accommodate all the characters in *Gross Profits*. Multiplan has not lost any of the information you have entered. It displays as much of it as it can in the space it has. If you give it more space, it will display the remainder of the characters.

When you started Multiplan, the column width was set at 10 characters. Column width is easily changed using the Format Width command.

The Format Width Command

Press F. On the command line you will see:

```

FORMAT: 10 Default Options Width
Select option or type command letter
RBC1  "Gross Profits"          99% Free   Multiplan: TEMP

```

At this point you need the Width subcommand. The other subcommands will be explained later. For now, however, press W. You will see:

```

                                     Proposed response: 1st field
FORMAT WIDTH in chars or d(default): 10 column: 1 through: 1
Enter number, or d for default
RBC1  "Gross Profit"          99% Free   Multiplan: TEMP

```

In the **1st field**, Multiplan shows "d" (for default) as the proposed response, but you may specify the number of characters of width you want. Since 10 characters (which is what you now have) is not wide enough to show your heading completely, choose the width you will need. *Gross Profits* has 13 characters (12 letters and 1 space). Select 15 characters of width to give yourself enough room. Type *15*. Now you see:

```

FORMAT WIDTH in chars or d(efault): 15 column: 1 through: 1
Enter number, or d for default
R8C1 "Gross Profit" 99% Free Multiplan: TEMP

```

Multiplan lets you select the columns you want to widen. The proposed response is to widen column 1 through column 1. As you only want to widen column 1 at this time, accept the proposed response; simply press RETURN (you don't need to TAB or change any responses).

#	1	2	3	4	5	6	7			
1										
2										
3	Sales									
4										
5	Cost									
6										
7										
8	Gross Profits									
9										
10										
11										
12										
13										
14										
15										
16										
17										
18										
19										
20										
COMMAND:	Blank	Copy	Delete	Edit	Format	Goto	Help	Insert	Lock	Move
	Name	Options	Print	Quit	Sort	Transfer	Value	Window	Xternal	
	Select option or type command letter									
R8C1	"Gross Profits"				99% Free					Multiplan: TEMP

Column width now accommodates cell entry

Gross Profits may now be seen fully in column 1 because that column has been widened. Your sheet is now ready for the first numbers.

Entering Numbers

Enter numbers

The sales figures for Spencer Ceramics show that the average amount of monthly sales last year was \$20,000.

Move the cell pointer to row 3, column 2 (R3C2) opposite *Sales*. Type 20000. (Use the numbers at the top of the keyboard.)

Note Multiplan handles commas in a special way (using the Format Options command), so you do not use commas (20,000) or spaces (20 000) when entering numbers. Also, you do not have to tell Multiplan that you want to enter a number, as you do for text (to enter text, you use the Alpha command). As soon as you type a digit from 0 to 9, Multiplan treats it as if you had selected the Value command.

Do not type the \$ now. Fill in all the figures first. You'll learn how to change them to dollars later.

Look at the command line.

Command line shows "value" after 0...9

```
VALUE: 20000█  
Enter formula  
R3C2  
99% Free Multiplan: TEMP
```

Press the DOWN direction key. Now you have:

	1	2	3	4	5	6	7
1							
2							
3	Sales	20000					
4							
5	Cost						
6							
7							
8	Gross Profits						
9							
10							
11							
12							
13							
14							
15							
16							
17							
18							
19							
20							
ALPHA/VALUE: █							
Enter text or value							
R4C2							
99% Free Multiplan: TEMP							

Notice that the ALPHA/VALUE: command line appears again, just as it did when you pressed the DOWN direction key after entering the titles.

Spencer Ceramics' costs were \$15,000 per month. Enter 15000 in row 5, column 2, like this:

- 1 Move the pointer to the desired cell (row 5, column 2).
- 2 Type 15000.
- 3 Press RETURN to enter the number in the cell.

Now your screen should look like this:

```

#1      1          2          3          4          5          6          7
1
2
3 Sales                20000
4
5 Cost                15000
6
7
8 Gross Profits
9
10
11
12
13
14
15
16
17
18
19
20
COMMAND: FFFF Blank Copy Delete Edit Format Goto Help Insert Lock Move
          Name Options Print Quit Sort Transfer Value Window Xternal
Select option or type command letter
R5C2    15000                99% Free      Multiplan: SPENCER

```

Display numbers as dollars

Since all the figures you are working with on this project have to do with finances, you may decide that it would be better to have all the numbers displayed as dollars. It's easy to make the change.

The Format Default Cells Command

Align your numbers

Multiplan offers a wide selection of formats in which cell entries may be displayed. The command used for this purpose is Format. Press F. You will see:

```

FORMAT: FFFF Default Options Width
Select option or type command letter
R5C2    15000                99% Free      Multiplan: TEMP

```

This time you want to change the format of all cells, so choose *Default*.

The command line shows:

```

FORMAT DEFAULT: GEN Width
Select option or type command letter
R5C2      15000      99% Free      Multiplan: TEMP
  
```

Now select the proposed response "Cells." The command line now shows:

```

FORMAT DEFAULT CELLS alignment: Ctr CTR Left Right
format code: Cont Exp Fix(Gen)Int $ * % # of decimals: 0
Select option
R5C2      15000      99% Free      Multiplan: TEMP
  
```

In the first field you will choose the alignment setting.

Alignment

Alignment means where text and numbers are placed in a cell; flush with the left edge, flush with the right edge, centered, or a mix of right and left (called General).

The "alignment" field offers you these choices:

Settings	Examples	Effect
Ctr	Sales \$1000.25 \$50.25	text and numbers centered
Gen	Sales \$1000.25 \$50.25	text flush left numbers flush right
Left	Sales \$1000.25 \$50.25	text and numbers flush left
Right	Sales \$1000.25 \$50.25	text and numbers flush right

1	2	3	4	5	6	7
1						
2						
3	Sales	\$20000.00				
4						
5	Cost	\$15000.00				
6						
7						
8	Gross Profits					
9						
10						
11						
12						
13						
14						
15						
16						
17						
18						
19						
20						

COMMAND: **Format** Blank Copy Delete Edit Format Goto Help Insert Lock Move
Name Options Print Quit Sort Transfer Value Window Xternal
Select option or type command letter
R5C2 15000 99% Free Multiplan: TEMP

You have made three choices in the Format command:

- 1 You selected Format Default Cells to choose settings for all cells.
- 2 You selected the proposed alignment of the contents of the cells.
- 3 You selected the display format for dollars (\$), which automatically gave you two decimal places.

Note You can change the way numbers are displayed any time you like without changing their values. For example, you could show the same value as 3, 3E0, \$3.00, or 300%, or even "****", depending on the format setting you select. See "Format" in Chapter 9, "Commands."

You have learned about formatting in this session, and you will learn more in the next chapter. You will also use a more detailed breakdown of costs to make a more comprehensive forecast for Spencer Ceramics.

Saving Work: The Transfer Save Command

Unless you save your worksheet, you will have to start over the next time you use Multiplan. To save your worksheet, use the Transfer Save command. Press T. The command line now shows:

```
TRANSFER: T Save Clear Delete Options Rename
Select option or type command letter
R5C2 15000 99% Free Multiplan: TEMP
```

To save your work, choose "Save" by pressing S.

```
TRANSFER SAVE filename: S
Enter filename
R5C2 15000 99% Free Multiplan: TEMP
```

Give your worksheet a meaningful filename, so that it will be easy to remember when you load the sheet in the next session. Type *SPENCER*.

```
TRANSFER SAVE filename: SPENCER
Enter filename
R5C2 15000 98% Free Multiplan: TEMP
```

You have replaced the name TEMP, which Multiplan had given the sheet in the absence of another name. From now on, you must ask for this file by its exact name when you want to load it, or Multiplan will not be able to find it.

Press RETURN to complete the command. Notice that the sheet name on the status line has changed to reflect the new sheet name.

Save your worksheet

Name your worksheet

```

COMMAND: FILE Blank Copy Delete Edit Format Goto Help Insert Lock Move
          Name Options Print Quit Sort Transfer Value Window Xternal
Select option or type command letter
R5C2      15000                                99% Free      Multiplan: SPENCER

```

New sheet name |

The Quit (Q) Command

The Quit command

To leave Multiplan, press Q (for Quit), as you did at the end of the last session:

```

QUIT:
Enter Y to save edits, N to lose edits, or cancel █
R5C2      100% Free      Multiplan: SPENCER

```

Since you've already saved your work, the message line just asks you to confirm that you want to quit.

Press Y. The screen should now be blank.

When you begin the next session, you will use the Transfer Load command to pick up where you left off.

Hint To save time and memory, keep your worksheet compact. Keep the amount of blank space within the worksheet to a minimum. Also, avoid extending the worksheet size unnecessarily.

Placing any number outside the general work area, even formatting a cell unintentionally, can use more memory and diskette storage than necessary.

If you suspect that too much memory is being used (check the % Free indicator at the bottom of the screen), try deleting all columns to the right and all rows below your work area on the sheet. This ensures the minimum size for your worksheet.

Summary

In this session you learned:

- How to use the Alpha (A) command to enter text.
- How to use BACKSPACE to correct typing errors by deleting characters.
- How to enter data using the direction keys.
- How to change the width of columns using the Format Width command.
- How to enter numbers in cells.
- How to change cells to the dollar format using the Format Default Cells command.
- What alignment settings are available.
- What format settings are available.
- How to save your work using the Transfer Save command.

1

2

3
4
5
6
7
8
9
10
11
12
13
14
15
16
17
18
19
20
21
22
23
24
25
26
27
28
29
30
31
32
33
34
35
36
37
38
39
40
41
42
43
44
45
46
47
48
49
50
51
52
53
54
55
56
57
58
59
60
61
62
63
64
65
66
67
68
69
70
71
72
73
74
75
76
77
78
79
80
81
82
83
84
85
86
87
88
89
90
91
92
93
94
95
96
97
98
99
100

3 Entering Formulas

In the last session you learned to put text (using the Alpha command) and numbers into cells by pointing to them with the cell pointer, typing the information in the command line, then entering it into the cell by pressing either RETURN or one of the direction keys.

You also learned to use the Format command to display numbers in dollar format.

At the end of the session you saved your worksheet in a file that you named *SPENCER*.

In this session you will get more practice in entering words and numbers and in formatting cells. Most important, you will learn to enter formulas.

Loading a File: The Transfer Load Command

When you start your Multiplan program, you will see that the row and column numbers appear on the screen, but not the information you typed in earlier. You have to load the file before that information will appear. Press T (for Transfer). The command line will show:

Load your worksheet

```
TRANSFER: Load Save Clear Delete Options Rename
Select option or type command letter
RLC1                               100% Free      Multiplan: TEMP
```

Multiplan has selected "Load" as its proposed response. Since you want to load your file into Multiplan, merely press RETURN (or press L). The command line will show:

TRANSFER LOAD filename: █

Enter filename or use direction keys to select from list
R1C1 100% Free Multiplan: TEMP

Type the name of the file you wish to load, *SPENCER*. You should see:

TRANSFER LOAD filename: SPENCER█

Enter filename or use direction keys to select from list
R1C1 100% Free Multiplan: TEMP

Then, press RETURN. Your file looks like this when it is loaded:

#	1	2	3	4	5	6	7
1							
2							
3	Sales		\$20000.00				
4							
5	Cost		\$15000.00				
6							
7							
8	Gross Profits						
9							
10							
11							
12							
13							
14							
15							
16							
17							
18							
19							
20							
COMMAND: Blank Copy Delete Edit Format Goto Help Insert Lock Move Name Options Print Quit Sort Transfer Value Window Xternal							
Select option or type command letter							
R5C2	15000			99% Free		Multiplan: SPENCER	

Notice that the cell pointer is at cell R5C2, just as it was when you saved this worksheet at the end of the last chapter.

The Insert Command

Look at the following breakdown of Spencer Ceramics' monthly costs:

Material	=	\$ 4,000.00
Labor	=	\$ 7,000.00
Overhead	=	\$ 4,000.00
Total Costs	=	\$15,000.00

Your worksheet must be expanded to make room for this new information. You will need space for Material, Labor, and Overhead, as well as *Total Costs*. It would be logical to place this information between the Costs and the Gross Profits titles.

To prepare for inserting this new information, move the cell pointer to R6C2.

To insert either empty rows or empty columns, use the Insert command. Press I.

Insert new information

INSERT: **Row** Column

Select option or type command letter
R6C2

99% Free

Multiplan: SPENCER

The proposed response, "Row," is what you want. (You need to add some extra rows of space.) Press RETURN to select "Row."

INSERT ROW # of rows: **1** before row: 6
between columns: 1 and: 255

Enter number
R6C2

99% Free

Multiplan: SPENCER

Notice that the proposed responses are based on the position of the cell pointer. Because the cell pointer is at row 6, Multiplan proposes the insertion of one row of space before row 6, extending from column 1 through 255; in other words, across the whole worksheet.

The new figures will require at least 5 rows (4 for figures and 1 for the total costs). Allow yourself enough room by adding 7 rows. Press 7.

Entering Additional Text

You will be able to add the new information in the space you have created. Under *Cost* (row 5), you will type the subcategories of *Material* in row 6, *Labor* in row 7, and *Overhead* in row 8. Leave a row of space between *Overhead* and *Total Costs* for a line, and type *Total Costs* in row 10. The procedure is the same as given in Chapter 2, and is summarized here:

- 1 Move the cell pointer to row 6, column 1 (using either the direction keys or the Goto command). Use the Alpha command.
- 2 Press A (or RETURN).
- 3 Type *Material*. If you make a mistake in entering text, BACKSPACE and type over the mistake.
- 4 Press the DOWN direction key to enter *Material*. Your screen now looks like this:

Row	1	2	3	4	5	6	7
1							
2							
3	Sales	\$20000.00					
4							
5	Cost	\$15000.00					
6	Material						
7							
8							
9							
10							
11							
12							
13							
14							
15	Gross Profits						
16							
17							
18							
19							
20							

ALPHA/VALUE: █

Enter text or value
RTCL

99% Free Multiplan: SPENCER

As in Chapter 2, the ALPHA/VALUE: command reappears after pressing a direction key, and the next character you type selects either the Alpha or the Value command.

Enter *Labor* in row 7 and *Overhead* in row 8 by simply typing the title then pressing the DOWN direction key.

Enter new information

Leave row 9 empty for now, and move the cell pointer to row 10. Enter *Total Costs*, as you entered *Labor* and *Overhead*. Your screen should now look like this:

#	1	2	3	4	5	6	7
1							
2							
3	Sales		\$20000.00				
4							
5	Cost		\$15000.00				
6	Material						
7	Labor						
8	Overhead						
9							
10	Total Costs						
11							
12							
13							
14							
15	Gross Profits						
16							
17							
18							
19							
20							

ALPHA/VALUE: █

Enter text or value
RI1C1

99% Free Multiplan: SPENCER

Entering Additional Numbers

Now you are ready to enter the numbers.

Move the cell pointer to row 6, column 2. Notice that the ALPHA/VALUE: command remains on the command line.

Type *4000*.

Press the DOWN direction key.

Type *7000*, and press the DOWN direction key.

For the last number (by *Overhead*), type *4000*, and press RETURN. You will see:

1	2	3	4	5	6	7
1						
2						
3	Sales	\$20000.00				
4						
5	Cost	\$15000.00				
6	Material	\$4000.00				
7	Labor	\$7000.00				
8	Overhead	\$4000.00				
9						
10	Total Costs					
11						
12						
13						
14						
15	Gross Profits					
16						
17						
18						
19						
20						

COMMAND: **FORM** Blank Copy Delete Edit Format Goto Help Insert Lock Move
 Name Options Print Quit Sort Transfer Value Window Xternal
 Select option or type command letter
 RBC2 4000 99% Free Multiplan: SPENCER

Aligning Cell Contents

To make it clear that the four entries under *Cost* (*Material*, *Labor*, *Overhead*, and *Total Costs*) are subcategories, you will want to align them to the right side of column 1. First position the cell pointer on the first cell to be aligned (row 6, column 1).

To align cells, use the Format command. Press F.

FORMAT: CELL Default Options Width
Select option or type command letter
R6C1 "Material" 99% Free Multiplan: SPENCER

From the command line choices, choose "Cells" (by pressing C or RETURN). The command line now shows:

Align cell contents

```

FORMAT cells: R6C1 alignment:(Def)Ctr Gen Left Right -
format code:(Def)Cont Exp Fix Gen Int $ * % - # of decimals: 0
Enter reference to cell or group of cells
R6C1 "Material" 99% Free Multiplan: SPENCER

```

The first field ("cells") shows the "active" cell (where the cell pointer is located, R6C1). We want first to align this single cell to the right to see how it looks. So, leave the proposed response as is.

TAB to the next field ("alignment"). To select an alignment here, use the same method you used for the Format Default Cells command in Chapter 2. Press R (for Right). The command line shows:

```

FORMAT cells: R6C1 alignment: Def Ctr Gen Left Right -
format code:(Def)Cont Exp Fix Gen Int $ * % - # of decimals: 0
Select option
R6C1 "Material" 99% Free Multiplan: SPENCER

```

The proposed response in the "format code" field is suitable and the "# of decimals" doesn't concern us now, so press RETURN. You will see:

Text aligns right

#	1	2	3	4	5	6	7
1							
2							
3	Sales	\$20000.00					
4							
5	Cost	\$15000.00					
6	Material	\$4000.00					
7	Labor	\$7000.00					
8	Overhead	\$4000.00					
9							
10	Total Costs						
11							
12							
13							
14							
15	Gross Profits						
16							
17							
18							
19							
20							

COMMAND: **Right** Blank Copy Delete Edit Format Goto Help Insert Lock Move
Name Options Print Quit Sort Transfer Value Window Xternal
Select option or type command letter
R6C1 "Material" 99% Free Multiplan: SPENCER

You also want to align rows 7 through 10 in column 1 to the right. You can align these four cells at once by using the symbol for “range,” as explained in the next section.

Ranges: The Colon

With Microsoft Multiplan, you can perform tasks on more than one cell at a time by typing two cell locations separated by a colon. Let's try this with *Labor*, *Overhead*, and *Total Costs* in column 1.

Select a range
with the colon

- 1 Move the cell pointer to *Labor* (R7C1).
- 2 Press F (for Format).
- 3 Press C (for Cells). You can now see R7C1 in the “cells” field:

```

FORMAT cells: R7C1 alignment:(Def)Ctr Gen Left Right -
format code:(Def)Cont Exp Fix Gen Int $ * % - # of decimals: 0
Enter reference to cell or group of cells
R7C1 "Labor" 99% Free Multiplan: SPENCER
  
```

- 4 Press the colon (:). Notice that the response in the field is not deleted. Multiplan helps you with entering a range that starts at the active cell.
- 5 Now let Multiplan do the work for you. Press the DOWN direction key until the cell pointer is in row 10 (R10C1). Notice the response in the “cells” field. It shows the range of cells you want to change.

#1	1	2	3	4	5	6	7
1							
2							
3	Sales	\$20000.00					
4							
5	Cost	\$15000.00					
6	Material	\$4000.00					
7	Labor	\$7000.00					
8	Overhead	\$4000.00					
9							
10	Total Costs						
11							
12							
13							
14							
15	Gross Profits						
16							
17							
18							
19							
20							

FORMAT cells: R1C1:R10C1 alignment:(Def)Ctr Gen Left Right -
 format code:(Def)Cont Exp Fix Gen Int \$ * % - # of decimals: 0
 Enter reference to cell or group of cells
 R10C1 "Total Costs" 99% Free Multiplan: SPENCER

Shows range of cells

- 6 TAB to the second field ("alignment"). In the second field, you again want to change the proposed response from "Def" (which aligns words to the left) to "Right."
- 7 Press R.
- 8 As before, the proposed responses in the other two fields are suitable, so press RETURN.

Your screen should now show you the new alignment for rows 6 through 10 in column 1:

	1	2	3	4	5	6	7
1							
2							
3	Sales	\$20000.00					
4							
5	Cost	\$15000.00					
6	Material	\$4000.00					
7	Labor	\$7000.00					
8	Overhead	\$4000.00					
9							
10	Total Costs						
11							
12							
13							
14							
15	Gross Profits						
16							
17							
18							
19							
20							

COMMAND: ~~HOME~~ Blank Copy Delete E it Format Goto Help Insert Lock Move
 Home Options Print Quit Sort Transfer Value Window Xternal
 Select option or type command letter
 R7C1 "Labor" 99% Free Multiplan: SPENCER

In Chapter 4, we will discuss "ranges" and other kinds of references to cells more fully.

The Blank Command

You are almost ready now to enter values for *Total Costs* in row 10.

Blank out a cell

When you do so, you will have two rows showing total costs. You started with *Costs* in row 5, and now you have another row for *Total Costs*. To correct this duplication, you will want to blank out the number \$15000.00 in row 5, column 2. The worksheet will be clearer if the heading *Cost* is left as a major category heading in column 1, but you want the number to appear next to *Total Costs*.

Use the Blank command to blank out the \$15000.00. First move the cell pointer to row 5, column 2.

Press B (for Blank). The command line shows:

```
BLANK cells: 150%
Enter reference to cell or group of cells
R5C2      15000      99% Free      Multiplan: SPENCER
```

Look at the cell number highlighted by the edit cursor. It shows you that the cell pointer is in row 5, column 2. All you have to do is press RETURN to erase the contents of that cell. Watch R5C2 as you press RETURN.

Active cell is now blank

1	2	3	4	5	6	7
1						
2						
3	Sales	\$20000.00				
4						
5	Cost					
6	Material	\$4000.00				
7	Labor	\$7000.00				
8	Overhead	\$4000.00				
9						
10	Total Costs					
11						
12						
13						
14						
15	Gross Profits					
16						
17						
18						
19						
20						

COMMAND: **BLANK** Blank Copy Delete Edit Format Goto Help Insert Lock Move
 Name Options Print Quit Sort Transfer Value Window Xternal
 Select option or type command letter
 R5C2 99% Free Multiplan: SPENCER

You can also use this command to blank out a group of cells. You can first press B (for Blank), then specify a range, as you did earlier for the Format Cells command. But we don't need to do this now.

Formulas

Now you are ready to enter a formula for calculating the total costs. The total costs in row 10 will be figured by adding the three rows above it. Move the cell pointer down next to *Total Costs* (row 10, column 2).

Building a Formula

You might be tempted not to bother with a formula. After all, you could just enter \$15000.00 because you already know that number belongs there. You need a formula, however, because costs may change; you need something that will work for other months, too, so that you don't have to calculate costs yourself every time.

Without touching any keys for a moment, think about what you will be doing. Point with your fingers to row 10, column 2 (next to *Total Costs*) on your display screen.

Think:

"*Total Costs* (row 10, column 2) . . .

Build a formula

11	1	2	3	4	5	6	7
1							
2							
3	Sales		\$20000.00				
4							
5	Cost						
6	Material	\$4000.00					
7	Labor	\$7000.00					
8	Overhead	\$4000.00					
9							
10	Total Costs						
11							
12							
13							
14							
15	Gross Profits						
16							
17							
18							
19							
20							

COMMAND: **F1** Blank Copy Delete Edit Format Goto Help Insert Lock Move
 Name Options Print Quit Sort Transfer Value Window Xternal
 Select option or type command letter
 R10C2 99% Free Multiplan: SPENCER

"will be the sum of (now point to row 6, column 2)
Material. . .

1	2	3	4	5	6	7
1						
2						
3	Sales	\$20000.00				
4						
5	Cost					
6		Material	\$4000.00			
7		Labor	\$7000.00			
8		Overhead	\$4000.00			
9						
10	Total Costs					
11						
12						
13						
14						
15	Gross Profits					
16						
17						
18						
19						
20						

COMMAND: **F7** Blank Copy Delete Edit Format Goto Help Insert Lock Move
 Name Options Print Quit Sort Transfer Value Window Xternal
 Select option or type command letter 99% Free Multiplan: SPENCER
 R10C2

"plus (now point to row 7, column 2) *Labor.* . .

1	2	3	4	5	6	7
1						
2						
3	Sales	\$20000.00				
4						
5	Cost					
6		Material	\$4000.00			
7		Labor	\$7000.00			
8		Overhead	\$4000.00			
9						
10	Total Costs					
11						
12						
13						
14						
15	Gross Profits					
16						
17						
18						
19						
20						

COMMAND: **F7** Blank Copy Delete Edit Format Goto Help Insert Lock Move
 Name Options Print Quit Sort Transfer Value Window Xternal
 Select option or type command letter 99% Free Multiplan: SPENCER
 R7C2 7000

"plus (now point to row 8, column 2) *Overhead*."

	1	2	3	4	5	6	7
1							
2							
3	Sales	\$20000.00					
4							
5	Cost						
6	Material	\$4000.00					
7	Labor	\$7000.00					
8	Overhead	\$4000.00					
9							
10	Total Costs						
11							
12							
13							
14							
15	Gross Profit						
16							
17							
18							
19							
20							

COMMAND: **F2** Blank Copy Delete Edit Format Goto Help Insert Lock Move
 Name Options Print Quit Sort Transfer Value Window Xternal
 Select option or type command letter
 R8C2 4000 99% Free Multiplan: SPENCER

You will follow the same procedure using your cell pointer.

Say to yourself

Do this

"Total Costs. . .

- 1 Place the cell pointer next to *Total Costs* (row 10, column 2).

1	1	2	3	4	5	6	7
2							
3	Sales		\$20000.00				
4							
5	Cost						
6		Material	\$4000.00				
7		Labor	\$7000.00				
8		Overhead	\$4000.00				
9							
10	Total Costs						
11							
12							
13							
14							
15	Gross Profits						
16							
17							
18							
19							
20							

COMMAND: **FILE** Blank Copy Delete Edit Format Goto Help Insert Lock Move
 Name Options Print Quit Sort Transfer Value Window Xternal
 Select option or type command letter
 R10C2 99% Free Multiplan: SPENCER

"equals. . .

- 2 Press =. (To begin a formula in Multiplan, press either = or V for the Value command.) Look at the command line.

VALUE: █	
Enter formula	
R10C2	99% Free Multiplan: SPENCER

"row 6 (*Material*) . .

- 3 Move the cell pointer up 4 rows to row 6. (Watch the formula being built on the command line. The entry R[-4]C is a formula to tell Multiplan to go up 4 rows in this column to find a value).

1						
2						
3	Sales	\$20000.00				
4						
5	Cost					
6	Material	\$7000.00				
7	Labor	\$7000.00				
8	Overhead	\$4000.00				
9						
10	Total Costs					
11						
12						
13						
14						
15	Gross Profits					
16						
17						
18						
19						
20						

VALUE: R[-4]C

Enter formula
R6C2 4000

99% Free Multiplan: SPENCER

"plus . .

- 4 Press +. Watch how the formula builds. Notice that the cell pointer moves back to its original position.

"row 7 (*Labor*) . .

- 5 Move the cell pointer to row 7.

"plus . .

- 6 Press +.

“row 8 (*Overhead*).”

7 Move the cell pointer next to *Overhead*.

1	2	3	4	5	6	7
2						
3	Sales	\$20000.00				
4						
5	Cost					
6	Material	\$4000.00				
7	Labor	\$7000.00				
8	Overhead	\$4000.00				
9						
10	Total Costs					
11						
12						
13						
14						
15	Gross Profits					
16						
17						
18						
19						
20						
	VALUE: RC-41C+RC-31C+RC-21C					
	Enter formula					
	R8C2	4000				
				99% Free		Multiplan: SPENCER

8 Press RETURN. You will see \$15000.00 now appear next to *Total Costs*. Look at the status line to see the formula Multiplan used to calculate the total.

	1	2	3	4	5	6	7
1							
2							
3	Sales		\$20000.00				
4							
5	Cost						
6		Material	\$4000.00				
7		Labor	\$7000.00				
8		Overhead	\$4000.00				
9							
10	Total Costs		\$15000.00				
11							
12							
13							
14							
15	Gross Profits						
16							
17							
18							
19							
20							
COMMAND: FILE Blank Copy Delete Edit Format Goto Help Insert Lock Move							
Name Options Print Quit Sort Transfer Value Window Xternal							
Select option or type command letter							
R10C2		R[-4]C+R[-3]C+R[-2]C		99% Free		Multiplan: SPENCER	

The dollar format you selected in Chapter 2 with the Format Default Cells command automatically gives you two decimal places. Because of this default setting, any numbers you enter will appear in dollars unless you specifically change them with the Format Cells command.

The formula you see on the status line is the way Multiplan states what you said as you built the formula.

Multiplan states:

$$\underbrace{R10C2} = \underbrace{R[-4]C} + \underbrace{R[-3]C} + \underbrace{R[-2]C}$$

- 1 "This cell is the active cell.
- 2 It contains. . .
- 3 the cell 4 rows up from here (or 'this row minus 4') in this column. . .
- 4 plus. . .
- 5 the cell 3 rows up from here. . .

The finished formula

- 6 plus . .
- 7 the cell 2 rows up from here.”

Note When a formula in Multiplan does not give a row or column number, it means the current row or column.

Reviewing or Changing a Formula

At some time later, you may forget exactly how you calculated the figure in a particular cell. You can see the contents of a cell by moving the cell pointer to it and looking at the status line.

If you wish to change the formula, place the cell pointer on that cell and use the Edit command (press E) to bring the formula onto the command line. Then use the CHARACTER RIGHT and CHARACTER LEFT keys with the BACKSPACE key to make the changes you want. (You can also use the DELETE key; refer to your Quick Reference Guide or Help information to find CHARACTER RIGHT, CHARACTER LEFT, and DELETE. CHARACTER RIGHT moves the edit cursor one character to the right; CHARACTER LEFT moves the edit cursor one character to the left; DELETE erases the character that is highlighted rather than the character to its left, as BACKSPACE does.)

These four keys are part of the editing keys that Multiplan provides you. All the editing keys are explained in Chapter 8, “Elements of Multiplan,” in the “Editing” section. Briefly, with the editing keys you can move the highlight around the command line, insert new text, and delete or replace old text.

The Status Line: Cell Contents

If a formula is too long to be shown in full on the status line, use Edit to place the formula in the command line so that you can review all of it.

The status line shows what is actually contained in the active cell. While the active cell may display the number \$15000.00, the status line will tell us what formula governs that cell. The value displayed for the cell may change, but the formula will remain constant. If, for example, the cost of materials were \$6000 instead of \$4000, the figure displayed in the *Total Costs* cell would change to \$17000.00. Yet, the status line would still show the same formula.

View and change a formula

Cell contents in the status line

Try it. Move the cell pointer to R6C2 (\$4000.00). Type 6000. Press RETURN and watch the display change to the following:

You change value

	1	2	3	4	5	6	7
1							
2							
3	Sales	\$20000.00					
4							
5	Cost						
6	Material	\$6000.00					
7	Labor	\$7000.00					
8	Overhead	\$4000.00					
9							
10	Total Costs	\$17000.00					
11							
12							
13							
14							
15	Gross Profits						
16							
17							
18							
19							
20							

COMMAND: **10** Blank Copy Delete Edit Format Goto Help Insert Lock Move
Name Options Print Quit Sort Transfer Value Window Xternal
Select option or type command letter
R6C2 6000 99% Free Multiplan: SPENCER

Multiplan recalculates

Total Costs now shows \$17000.00. Now, change the cost of materials back to \$4000.00 and watch *Total Costs* change back to \$15000.00.

Drawing Lines

To make the worksheet easier to read, draw a line in row 9, column 2, using dashes to separate the subcategories from *Total Costs*. Follow the same procedure you used earlier to enter text:

- 1 Move the cell pointer to row 9.
- 2 Press A (for Alpha).

Draw a line

Note If you missed this step and tried to enter the dash without the Alpha command, the command line would show VALUE and be ready for a negative number or a formula. If you did do this, press the CANCEL key, and start this step over again.

3 Type the dash 10 times to fill the spaces in the cell:

```
ALPHA: -----  
Enter text  
R9C2                               99% Free   Multiplan: SPENCER
```

4 Press RETURN.

You now see:

```
#1 1 2 3 4 5 6 7  
2  
3 Sales $20000.00  
4  
5 Cost  
6 Material $4000.00  
7 Labor $7000.00  
8 Overhead $4000.00  
9  
10 Total Costs $15000.00  
11  
12  
13  
14  
15 Gross Profits  
16  
17  
18  
19  
20  
COMMAND: VALUE Blank Copy Delete Edit Format Goto Help Insert Lock Move  
Name Options Print Quit Sort Transfer Value Window Xternal  
Select option or type command letter  
R9C2 "-----" 99% Free Multiplan: SPENCER
```

You will learn later how to extend this line across the entire worksheet, or across as many columns as you wish. Later, you will also get more practice in entering formulas using the cell pointer.

The Transfer Save Command (Review)

Save your work by using the Transfer Save command as you did before.

Press T. The command line shows:

```
TRANSFER: T Save Clear Delete Options Rename
Select option or type command letter
R9C2 "-----"          99% Free      Multiplan: SPENCER
```

Choose Save by pressing S. Now the command line shows:

```
TRANSFER SAVE filename: S SPENCER
Enter filename
R9C2 "-----"          99% Free      Multiplan: SPENCER
```

The proposed response is the last filename used, *SPENCER*. Since that is what you want, press RETURN.

```
TRANSFER SAVE filename: SPENCER
Enter Y to overwrite file
R9C2 "-----"          99% Free      Multiplan: SPENCER
```

Multiplan asks you to confirm

Multiplan is now asking you to enter *Y* if you want the worksheet on the screen to replace the one in the file. Since you do want your new work saved, press *Y* (for Yes). The command line will now return to:

```
COMMAND: Y Blank Copy Delete Edit Format Goto Help Insert Lock Move
Name Options Print Quit Sort Transfer Value Window Xternal
Select option or type command letter
R9C2 "-----"          99% Free      Multiplan: SPENCER
```

Any time you select a command that can affect a worksheet as a whole, Multiplan will ask you to confirm the action by pressing *Y*.

Save your worksheet

This is true of worksheets on the screen and worksheets in a disk file. These actions include, for example, saving a file under a name previously used, or quitting a Multiplan session.

Your worksheet has been saved. Leave Multiplan for this session by pressing Q (Quit) and Y (Yes) to confirm.

Summary

In this session you learned:

- How to load your file.
- How to create more space by inserting empty rows using the Insert command (I).
- How to enter additional text using the Alpha command with the direction keys.
- How to enter additional numbers.
- How to align the contents of specific cells.
- How to specify a group of cells using the range symbol (colon).
- How to erase the contents of specific cells using the Blank (B) command.
- How to build formulas using the cell pointer and how to read the formula on the status line.
- How to use the cell pointer and the status line to review a formula, and how to use the cell pointer and the Edit command (E) to change a formula.
- How to draw a line using the dash (-).
- How to save your new work with the Transfer Save command (writing over old work).

4 Naming Cells and Copying

In the last session, you entered cost figures into the worksheet. You then built a formula for *Total Costs* using the cell pointer.

In this session you will practice building more formulas. You will also learn how to copy cells and how to name them.

The Transfer Load Command (Review)

Load Multiplan. Now load your file. To review:

- 1 Press T (Transfer).
- 2 Press L or RETURN (to select Load).
- 3 Type *SPENCER*.
- 4 Press RETURN.

Load your worksheet

Your screen should show:

```

#1      1          2          3          4          5          6          7
1
2
3 Sales                $20000.00
4
5 Cost
6     Material $4000.00
7     Labor $7000.00
8     Overhead $4000.00
9
10    Total Costs $15000.00
11
12
13
14
15 Gross Profits
16
17
18
19
20
COMMAND: [F5] Blank Copy Delete Edit Format Goto Help Insert Lock Move
          Name Options Print Quit Sort Transfer Value Window Xternal
Select option or type command letter
R9C2    "-----"          99% Free      Multiplan: SPENCER

```

Titles

Title your columns

You need to be able to tell which month is which, so you will want to put the names of the months across the top of the worksheet. Move the cell pointer to row 1, column 2.

	1	2	3	4	5	6	7
1							
2							
3	Sales	\$20000.00					
4							
5	Cost						
6	Material	\$4000.00					
7	Labor	\$7000.00					
8	Overhead	\$4000.00					
9							
10	Total Costs	\$15000.00					
11							
12							
13							
14							
15	Gross Profits						
16							
17							
18							
19							
20							

COMMAND: **ALPHA** Blank Copy Delete Edit Format Goto Help Insert Lock Move
 Name Options Print Quit Sort Transfer Value Window Xternal
 Select option or type command letter
 RIC2 99% Free Multiplan: SPENCER

You want to enter the months starting with January in row 1, column 2, so press A (for the Alpha command):

ALPHA: █
 Enter text
 RIC2 99% Free Multiplan: SPENCER

Type *January*.

ALPHA: January█
 Enter text
 RIC2 99% Free Multiplan: SPENCER

Press the RIGHT direction key to move the cell pointer to the next cell, row 1, column 3. Remember that moving the cell pointer automatically enters the word and places you in the ALPHA/VALUE: command each time you press a direction key to enter data; there is no need to press RETURN or Alpha each time.

#	1	2	3	4	5	6	7
1		January					
2							
3	Sales	\$20000.00					
4							
5	Cost						
6	Material	\$4000.00					
7	Labor	\$7000.00					
8	Overhead	\$4000.00					
9							
10	Total Costs	\$15000.00					
11							
12							
13							
14							
15	Gross Profits						
16							
17							
18							
19							
20							
	ALPHA/VALUE:						
	Enter text or value						
	RIC3			99% Free		Multiplan: SPENCER	

Follow the same procedure until you have listed all twelve months. You will automatically scroll the screen as you move the cell pointer. Press RETURN after the last month to enter the final title and to return to the main command menu.

11	8	9	10	11	12	13	14
1	July	August	September	October	November	December	
2							
3							
4							
5							
6							
7							
8							
9							
10							
11							
12							
13							
14							
15							
16							
17							
18							
19							
20							

COMMAND: **F12** Blank Copy Delete Edit Format Goto Help Insert Lock Move
 Name Options Print Quit Sort Transfer Value Window Xternal
 Select option or type command letter
 RIC13 "December" 99% Free Multiplan: SPENCER

Move the pointer back to January (row 1, column 2).

11	1	2	3	4	5	6	7
1		January	February	March	April	May	June
2							
3	Sales	\$20000.00					
4							
5	Cost						
6	Material	\$4000.00					
7	Labor	\$7000.00					
8	Overhead	\$4000.00					
9		-----					
10	Total Costs	\$15000.00					
11							
12							
13							
14							
15	Gross Profits						
16							
17							
18							
19							
20							

COMMAND: **F12** Blank Copy Delete Edit Format Goto Help Insert Lock Move
 Name Options Print Quit Sort Transfer Value Window Xternal
 Select option or type command letter
 RIC2 "January" 99% Free Multiplan: SPENCER

Format: Align Center

Center your column titles

The names of the months, because they are text, are aligned left in the Multiplan "General" format (the format in which your worksheet began). The worksheet would look nicer and be easier to follow if the names of the months were centered over the columns. Use the Format Cells command with the "Center" alignment to accomplish this.

Press F.

```

FORMAT: C Default Options Width
Select option or type command letter
R1C2 "January" 99% Free Multiplan: SPENCER
  
```

Press C or RETURN (for Cells).

```

FORMAT cells: R1C2 alignment:(Def)Ctr Gen Left Right -
format code:(Def)Cont Exp Fix Gen Int $ * % - # of decimals: 0
Enter reference to cell or group of cells
R1C2 "January" 99% Free Multiplan: SPENCER
  
```

You want to format all twelve months, so you could follow the same procedure you used earlier to format a range of cells (the subheadings for *Cost*). But it is much faster and more efficient to format the whole row at once.

Refer to your Quick Reference Guide or the Help Keyboard command for the CHARACTER RIGHT key. Press the CHARACTER RIGHT key to move the edit cursor to the end of the proposed response in the first field (R1C2).

Format a whole row

Earlier, instead of pressing the RIGHT direction key a number of times to give the range, we typed colon and another cell reference. This time we want to format a whole row. You could type the column numbers yourself (1:255), but there's a more efficient way. Simply delete the C2 from the cell reference, using BACKSPACE.

```

FORMAT cells: R1C2 alignment:(Def)Ctr Gen Left Right -
format code:(Def)Cont Exp Fix Gen Int $ * % - # of decimals: 0
Enter reference to cell or group of cells
R1C2 "January" 99% Free Multiplan: SPENCER

```

This leaves the response as R1, which tells Multiplan to format the whole row. (Similarly, C1 would mean format all of column 1.)

Press TAB to move to the second field. Type C to choose "Center."

Press RETURN now because the proposed response in the "format code" field is correct and the "# of decimals" field does not apply.

The names of the months are now aligned in the center over the columns of numbers and are easier to read.

The Copy Right Command

The figures you entered for Spencer Ceramics were for only one month. You will also want to show the rest of the year. Start by copying the figures you have for January into the remaining months of the year (the next eleven columns). You can later change some figures for costs or sales to see the effects of the changes on Spencer Ceramics' profits.

To copy the number for *Sales* (\$20000.00) into the next eleven cells, move the cell pointer to \$20000.00 (row 3, column 2). Press C (for Copy). Your command line shows:

```

COPY: R1C2 Down From
Select option or type command letter
R3C2 20000 99% Free Multiplan: SPENCER

```

Choose the Right subcommand to copy from one cell (for January) into the cells to its right. Press R. The command line shows:

```

COPY RIGHT number of cells: 11 starting at: R3C2
Enter number
R3C2 20000 99% Free Multiplan: SPENCER

```

The Copy Right command

Where the edit cursor is located, type *11*, for the number of times you want the formula in R3C2 copied.

```

COPY RIGHT number of cells: 11 starting at: R3C2
Enter number
R3C2      20000          99% Free      Multiplan: SPENCER

```

Multiplan has proposed the cell you want to copy (the location of the cell pointer) as the starting point. You have already specified how many copies of that cell you want.

Press RETURN.

```

11  1          2          3          4          5          6          7
12  1          January  February  March     April     May       June
13  2 Sales      $20000.00 $20000.00 $20000.00 $20000.00 $20000.00
14  3
15  4 Cost
16  5 Material $4000.00
17  6 Labor    $7000.00
18  7 Overhead $4000.00
19  8 -----
20  9 Total Costs $15000.00
21  10
22  11
23  12
24  13
25  14
26  15 Gross Profits
27  16
28  17
29  18
30  19
31  20
32  COMMAND:  Blank Copy Delete Edit Format Goto Help Insert Lock Move
33           Name Options Print Quit Sort Transfer Value Window Xternal
34  Select option or type command letter
35  R3C2      20000          99% Free      Multiplan: SPENCER

```

The screen is too small to display the whole year at one time, but you can see the rest of the year by using the direction keys to scroll the sheet beneath the pointer. Scroll until both columns 13 and 14 are visible. The sales figures stop at column 13 (the last of the twelve months of the year).

1	8	9	10	11	12	13	14
2	July	August	September	October	November	December	
3	\$20000.00	\$20000.00	\$20000.00	\$20000.00	\$20000.00	\$20000.00	
4							
5							
6							
7							
8							
9							
10							
11							
12							
13							
14							
15							
16							
17							
18							
19							
20							

COMMAND: **F1** Blank Copy Delete Edit Format Goto Help Insert Lock Move
 Name Options Print Quit Sort Transfer Value Window Xternal
 Select option or type command letter
 R3C14 99% Free Multiplan: SPENCER

Now, fill in the cost figures, again using the Copy command. Instead of copying one row at a time (as you did when you copied the \$20000.00 for *Sales*), use the Copy Right command to copy a group of cells.

First, move the cell pointer to the upper left corner of the area you want to copy. You want to copy the information from rows 6 through 10 in column 2, to the same rows in columns 3 through 13 to fill in the rest of the months. Move the cell pointer to row 6 in column 2.

#	1	2	3	4	5	6	7
		January	February	March	April	May	June
3	Sales	\$20000.00	\$20000.00	\$20000.00	\$20000.00	\$20000.00	\$20000.00
5	Cost						
6	Material	\$4000.00					
7	Labor	\$7000.00					
8	Overhead	\$4000.00					
10	Total Costs	\$15000.00					
15	Gross Profits						

COMMAND: **COPY** Blank Copy Delete Edit Format Goto Help Insert Lock Move
 Name Options Print Quit Sort Transfer Value Window Xternal
 Select option or type command letter
 R6C2 4000 99% Free Multiplan: SPENCER

Press C (for Copy).

COPY: 11 Down From
Select option or type command letter
R6C2 4000 99% Free Multiplan: SPENCER

Press R (for Right).

COPY RIGHT number of cells: 11 starting at: R6C2
Enter number:
R6C2 4000 99% Free Multiplan: SPENCER

Same as last time command was used

Notice that the "number of cells" field shows **11**, the same number you typed the last time you used the Copy Right command. Multiplan will always propose the number you used for the last Copy Right command. The number you want is the number **11** (this copying is just like the one for *Sales*).

Press TAB to move to the "starting at" field.

COPY RIGHT number of cells: 11 starting at: R6C2
 Enter reference to cell or group of cells
 R6C2 4000 99% Free Multiplan: SPENCER

If you were copying only one row, the proposed response would be right. But you want to copy 5 rows of column 2 to the right, so you need to enter a range.

Press : (colon).

COPY RIGHT number of cells: 11 starting at: R6C2:
 Enter reference to cell or group of cells
 R6C2 4000 99% Free Multiplan: SPENCER

Colon (:) to build a "range"

Press the DOWN direction key until the cell pointer is on \$15000.00 (next to *Total Costs*).

COPY RIGHT number of cells: 11 starting at: R6C2:R10C2
 Enter reference to cell or group of cells
 R10C2 R1-41C+R1-31C+R1-21C 99% Free Multiplan: SPENCER

Use direction key for end cell

Notice how easily the range has been built.

Press RETURN and watch the values appear across the screen. The values for *Total Costs* appear last because they involve copying a formula; Multiplan has to calculate the value after it finishes copying the formulas. You should now see:

	1	2	3	4	5	6	7
	January	February	March	April	May	June	
3	Sales	\$20000.00	\$20000.00	\$20000.00	\$20000.00	\$20000.00	\$20000.00
5	Cost						
6	Material	\$4000.00	\$4000.00	\$4000.00	\$4000.00	\$4000.00	\$4000.00
7	Labor	\$7000.00	\$7000.00	\$7000.00	\$7000.00	\$7000.00	\$7000.00
8	Overhead	\$4000.00	\$4000.00	\$4000.00	\$4000.00	\$4000.00	\$4000.00
10	Total Costs	\$15000.00	\$15000.00	\$15000.00	\$15000.00	\$15000.00	\$15000.00
15	Gross Profits						

COMMAND: Blank Copy Delete Edit Format Goto Help Insert Lock Move
Name Options Print Quit Sort Transfer Value Window Xternal
Select option or type command letter
R6C2 4000 99% Free Multiplan: SPENCER

Formulas (Review)

A formula will do calculations for you, plus it allows you to change the numbers and have Multiplan recalculate the result. So you want to build formulas wherever you can.

Build a gross profits formula

In Chapter 3, you built a formula to calculate *Total Costs*. Now, you want to build a formula to calculate *Gross Profits*. Say to yourself, "*Gross Profits* is *Sales* minus *Total Costs*." A formula that uses these names is easily recognizable and as easy to build as the formulas you have built already. Before you can build such a formula, you must define names for some cells.

Naming Cells

Multiplan has a way to name cells or groups of cells, so that you can refer to them easily. You can, for example, name a whole row, such as row 3; you can name it *Sales*, meaning the whole line of numbers showing sales. If you could see your whole screen at once, you could imagine the row named *Sales*. It would look like this:

"Sales" (Row 3 col. 2:13)

1	2	3	4	5	6	7	8	9	10	11	12	13	14
	Jan	Feb	Mar	April	May	June	July	Aug	Sept	Oct	Nov	Dec	
3	Sales												
4													
5													
6													
7													
8													
9													
10													
11													
12													
13													
14													
15													
16													
17													
18													
19													
20													

COMMAND: **File** Blank Copy Delete Edit Format Goto Help Insert Lock Move
 Name Options Print Quit Sort Transfer Value Window Xternal
 Select option or type command letter 99% Free Multiplan: TEMP
 R6C5

Note When you name a cell or group of cells, make the name one long word; do not use spaces or hyphens. (For more information, see the discussion of the Name command in Chapter 9, "Commands.")

To build a formula for *Gross Profits*, you must first name the groups of cells that contain sales and total cost figures. Then these names can be used to build your formula.

Start by naming row 3 *Sales*.

Move the cell pointer to R3C1 (row 3, column 1).

Press N (for Name).

NAME: define name: Sales	to refer to: R3C1
macro: Yes(No)	command key(s):
Enter name	
R3C1 "Sales"	99% Free Multiplan: SPENCER

Text in active cell used for proposed response

In the first field, Multiplan proposes *Sales* as the name to be defined. This is helpful for quickly turning titles on a worksheet

Name a group of cells

into names. Titles are text that you place in a cell. Names are references to areas on the worksheet. A name may be the same as a title, as it is here. But the area the name refers to may be different from the area that contains the title, again as it is here.

Press TAB to move to the next field.

```

NAME: define name: Sales          to refer to: R3C1
macro: Yes(No)                  command key(s):
Enter reference to cell or group of cells
R3C1    "Sales"                  99% Free    Multiplan: SPENCER
  
```

Message changes

Notice that when you tabbed to the “to refer to” field, the message changed to “Enter reference to cell or group of cells.” Multiplan is asking you to specify which cells this name refers to.

You want *Sales* to refer to the cells in row 3, columns 2 through 13. Press the RIGHT direction key once; the response in the “to refer to” field is now R3C2. Press : (colon), then the RIGHT direction key to move the cell pointer to column 13 (December). You should see:

```

NAME: define name: Sales          to refer to: R3C2:R3C13
macro: Yes(No)                  command key(s):
Enter reference to cell or group of cells
R3C13    20000                  99% Free    Multiplan: SPENCER
  
```

Press RETURN.

(For more information on the “define name” and “to refer to” fields, see the Name command in Chapter 9, “Commands,” and Appendix A, “Macros.”)

You could have typed *13* after the colon instead of using the cell pointer. This method is faster if you know which cells compose the group you are naming.

Now name the group of cells that defines *Total Costs*.

Move the cell pointer to *Total Costs* (R10C1).

Press N (for Name).

Reference to Multiplan

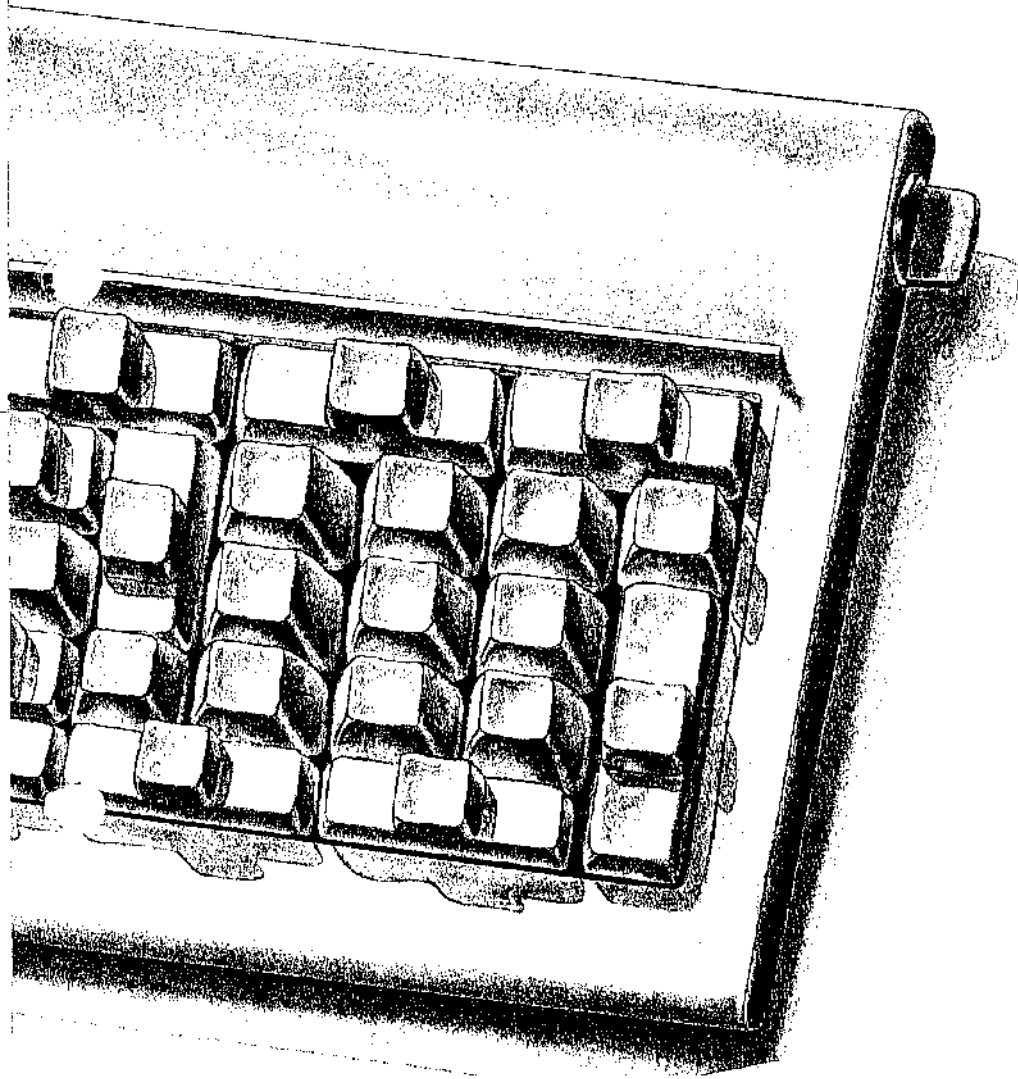

Reference to Multiplan

Use these chapters for more detailed information:

- 8 Elements of Multiplan
- 9 Commands
- 10 Functions
- 11 Messages

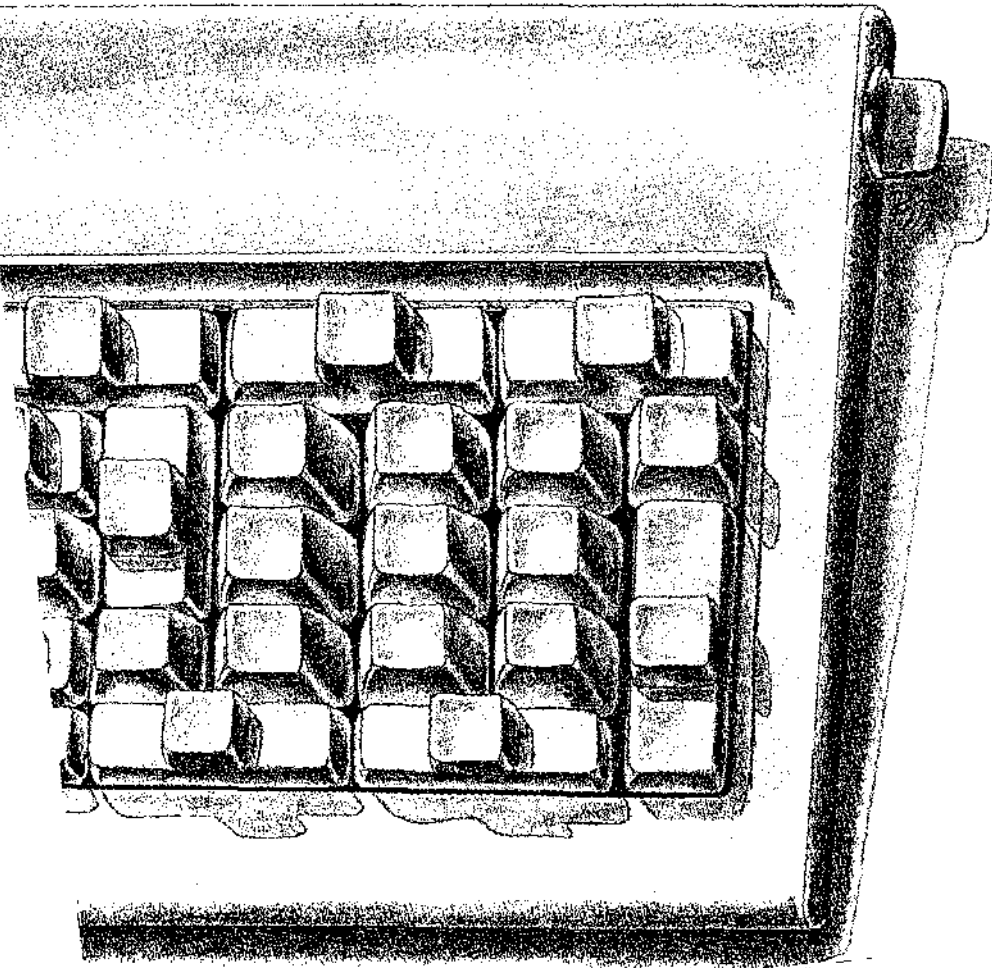





8 Elements of Multiplan

This chapter is divided into seven sections that describe Multiplan structure, features, and operation. Details of the commands, functions, and messages are described in separate chapters and are covered only generally in this chapter.

The Microsoft Multiplan Worksheet

The worksheet

The worksheet is a rectangle with an arrangement of intersecting rows and columns. The sheet may be up to 255 columns wide and 4095 rows long. An area one column wide by one row high is called a cell.

Each cell possesses both a value that may be displayed on the Multiplan screen and a formula for computing that value. This formula may be as simple as the number 19.95, or it may be more complex, containing functions and references to other cells; for example, "previous cell times growth rate."

The potential dependence of the value of one cell on the values in other cells is the key idea behind the worksheet. When cells have been connected by references among them, a change in one cell (for example, changing 19.95 to 18.50), causes Multiplan to calculate the effect of the change on all other cells. This process is called "recalculating the worksheet." Recalculation may be automatic after every change, or it may be turned off (see Options command, Chapter 9, "Commands"). When automatic recalculation is turned off, one-time recalculation may be caused by pressing the RECALC key (!).

The order of calculating the cells is automatically chosen by Multiplan so that the calculation of each cell precedes the calculation of other cells that depend on it. If such an order is impossible, the "Circular references unresolved: *cell reference*" error message is displayed.

The Multiplan screen is a movable "window" through which to view part of the worksheet. When Multiplan starts, only one window is open. You may open up to eight windows to the worksheet. Each window opened is given a consecutive window

The basic screen

number. For the following discussion, assume that only one window is open, just as when you start a Multiplan session.

Across the top of the window are column numbers. Down the left edge of the window are row numbers. The row and column numbers tell you what area of the worksheet you are viewing.

Somewhere within the window is a highlighted cell. The highlight is called the cell pointer, and it points to the "active cell." Many operations do something with the active cell.

The command line

Across the bottom of the screen are four lines of text. The top two lines are called the command line. The actions you want Multiplan to perform are selected from these commands. The command line is discussed more in the "Entering Commands" section below. The commands are described in Chapter 9, "Commands."

The message line

Just below the command line is the message line. The message line shows either an error message or a prompt message. An error message indicates what the problem is. A prompt message indicates in general terms your next step in entering a command. The prompt message changes as you work your way through a command. See the "Entering Commands" section for more information about command entry and Chapter 11, "Messages," for explanations of message line messages.

The status line

The bottom line on the screen is called the status line. Here, Multiplan displays the position of the cell pointer, the current contents of the active cell, the percent of free memory, the status of special keys, and the name of the active sheet.

The position (row number and column number) of the active cell is shown first on the status line. The formula used for calculating the value of the active cell is shown next to the coordinates. When the contents of the active cell are text or numbers, the status line shows the text in double quotation marks or the number itself.

The cell pointer can be moved around by using the direction keys.

UP moves the cell pointer toward the top of the window.

DOWN moves the cell pointer toward the bottom of the window.

LEFT moves the cell pointer toward the left edge of the window.

RIGHT moves the cell pointer toward the right edge of the window.

When the cell pointer reaches the edge of the window, the window begins to move across the worksheet one cell at a time. This is called scrolling. When the cell pointer reaches the edge of the worksheet, the cell pointer stops, and the Multiplan alarm sounds.

The page keys scroll across the worksheet a whole windowful at a time in the direction selected.

The HOME key may be used to go to row 1, column 1 quickly. The END key may be used to go to the last row and last column of the active area of the worksheet. The active area is the smallest rectangle that encompasses the cell in the upper left corner of the worksheet (row 1, column 1; referred to as R1C1) and the last cell to the right and down that has been given contents or formatting. When Multiplan starts, HOME and END are both at R1C1.

Scrolling

The HOME and END keys

Entering Commands

You direct Multiplan to perform the tasks you want done by entering commands. The commands are described individually in Chapter 9, "Commands." This section describes the methods of command entry.

You select a command when the main command menu is on the screen. The main command menu shows the choice of commands:

```
COMMAND: Alpha Blank Copy Delete Edit Format Goto Help Insert Lock Move
          Name Options Print Quit Sort Transfer Value Window Xternal
```

When this menu is on display, Multiplan is waiting for you to select a command. When Multiplan is computing, the main command menu is not visible and no message appears on the message line. When the main command menu reappears, Multiplan is ready for more commands.

Some of the main commands have subcommands. In these cases, when the main command has been chosen, the main command menu is replaced with a subcommand menu.

Remember: the message line shows a prompt message that indicates your next step in entering the command. See Chapter 11, "Messages," for descriptions of these messages.

To enter a command:

Entering commands

Canceling a command

- 1 Select an active cell (move the cell pointer to the appropriate cell), if required by the command to be selected.
- 2 Select a command.
- 3 Select responses for the command fields. The responses are used to specify where to Goto, what to Format, where and how to split windows, and so forth.
- 4 Press RETURN to carry out the command. Or, press CANCEL during the first three steps to cancel the command.

Selecting the active cell is described in the section above, entitled "The Microsoft Multiplan Worksheet." Steps 2 and 3 are described below.

Select a Command

Selecting a command

When you are prompted to select an option from a menu, select in one of two ways:

- Type the first letter of the option you want.
or
- Use SPACE and BACKSPACE to move the highlight to the appropriate command word. SPACE moves the highlight to the right, BACKSPACE to the left. Press RETURN.

When you have selected a command, Multiplan displays the main command name followed by either a subcommand menu or one or more command fields. Typically, a new subcommand menu will follow selection of a main command. Select a subcommand as you would a main command.

The command line will show the command and subcommands you have already selected in capital letters. For example:

```
WINDOW: Split Border Close Link Paint
```

Now if "Split" is selected, the command line changes to:

```
WINDOW SPLIT: Horizontal Vertical Titles
```

Continue selecting subcommands until the command fields are displayed. The names of command fields are shown in lowercase letters followed by a colon. For example:

```
WINDOW SPLIT HORIZONTAL at row: ?   linked: Yes(No)
```

This command line has two fields: the “at row” field and the “linked” field. Note that the “linked” field contains a small menu.

Select Responses for the Command Fields

The next step is to enter responses for the command field or fields. There may already be responses in the fields. These are responses proposed by Multiplan. If a proposed response suits your purpose, you need not enter a response in that field. In fact, if the proposed responses in all the fields are suitable, you can just press RETURN to carry out the command.

Entering responses proceeds field by field starting at the first one. A highlight indicates the “active” field (the field in which a response is being entered). Other fields will not contain a highlight.

To move the highlight from field to field, press the TAB key. Pressing the TAB key when the highlight is in the last field returns it to the first field.

The message line gives you messages prompting entries in the command fields. Whenever the message line starts with “Enter. . .,” the field must be filled in. To “fill in” the field, either accept the proposed response or simply type the characters. For example:

```
TRANSFER LOAD filename: INCOME
```

```
Enter filename or use direction keys to select from list
```

where *INCOME* was typed. In this case, there is only one field, and the TAB key is not needed. Simply press RETURN to carry out the command.

In certain fields, the direction keys may be used to view and select from a list of possible responses. The message line will indicate when the direction keys may be used. The RIGHT DIRECTION key will propose the next response on the list; the LEFT, the previous response. The UP DIRECTION key will propose the first response on the list; the DOWN, the last response.

When the message line shows “Select option,” the field contains a menu of options. Select the option you want by either of the two methods used for selecting commands: either type the initial letter or use SPACE and BACKSPACE to move the highlight to your choice. Note that when a command field with a menu is not active, the current option is shown enclosed in parentheses, as in the “linked” field in the example above.

Selecting proposed responses

Proposed responses

Proposed Responses

The proposed response depends on the specific command; thus proposed responses are described with the commands in Chapter 9, "Commands." However, proposed responses follow a few general principles:

- When a command field contains a menu, the "proposed" response is the current setting. For example, the Options command initially appears as:

```
OPTIONS recalc: Yes(No)      mute: Yes(No)
           iteration: Yes(No)  completion test at:
```

with the highlight on Yes showing the current setting in the "recalc" field and the parentheses showing the current setting in the "mute" field. Thus, the same menu may be used to inspect as well as select options in command fields.

- In other fields, the proposed response will be the one entered the last time the command was used. This simplifies entering a series of related commands.
- Yet other fields reflect the position or contents of the active cell. For this reason, positioning the cell pointer before selecting a command may be helpful.

All proposed responses may be edited by using Multiplan editing keys, described in the "Editing" section below.

Editing

Editing

Microsoft Multiplan provides editing keys to edit responses in command fields. Multiplan editing can be used any time you are entering responses in command fields. To edit the contents of cells, move the cell pointer to the cell, then use the Alpha command for cells with text or the Edit command for cells with formulas, and edit the proposed responses in the command line.

Either just after a command is selected or just after pressing the TAB key, the whole field containing a proposed response is highlighted.

Editing a proposed response

To *replace* the proposed response: Type the replacement. Multiplan automatically deletes the proposed response as you type the new one.

To *delete* the proposed response and leave the field empty: Press DELETE. All text that is highlighted is deleted.

To *append* to the proposed response: For cell references (when the message line shows “Enter reference to cell or group of cells”), type a colon (:) or other operator. For other responses, press either the CHARACTER RIGHT or the WORD RIGHT key, then type the additional text.

Once the proposed response is altered, one character or word in the field is highlighted. This highlight is the edit cursor. The edit cursor may be moved to designate where or what to edit.

Use CHARACTER LEFT, CHARACTER RIGHT, WORD LEFT, and WORD RIGHT keys to move the edit cursor.

The CHARACTER LEFT and CHARACTER RIGHT keys move the edit cursor left or right one character.

The WORD LEFT and WORD RIGHT keys move the edit cursor left or right highlighting words or the space or punctuation between words. In formulas, the values and the operators are highlighted alternately.

To *insert* new text: Type the text. It will be inserted in front of the edit cursor.

To *delete* text: Use BACKSPACE to delete characters on the left side of the cursor. Use DELETE to delete what is highlighted by the cursor.

To *replace* text: Delete the old text and type the new.

The following formula-editing keys simplify the typing of formulas. These keys all insert text in front of the edit cursor:

- As you begin to enter a formula or just after you enter an operator, the direction keys (as well as the HOME and END keys) can be used to enter a relative cell reference of the form $R[\pm n]C[\pm m]$ in the field by pointing to the cell you want (see the “Formulas” section below for an explanation of cell references, relative references, absolute references, and Names). As you move the cell pointer, the reference will change accordingly. The cell pointer will return to its original position as soon as any key other than a direction key is pressed.
- Similarly, the direction keys can be used to enter absolute references of the form $Rn Cm$ in fields that accept a cell reference (when the message line shows “Enter reference to cell or group of cells”).
- Relative references created with direction keys (described under the first item above) may be changed to absolute references by pressing the REFERENCE key (@) immediately after the direction keys.

Editing formulas

- Names may be entered easily by pressing the REFERENCE key first, then using the direction keys to step through the list of defined names.
- Finally, a formula may be replaced with its resulting value by pressing the RECALC key (!) after the formula is entered.

Formulas

Formulas

Formulas are “recipes” for calculating values. When these values are displayed on the computer screen or printed on a printer, they compose the results of a Multiplan worksheet.

Multiplan works with different types of values, which are appropriate in different circumstances:

Value	Use
numbers	used for financial, statistical, scientific, and other calculations.
text	characters treated as words, including numbers in special displays, such as \$10.00 or 6/14/81. Text is always shown in double quotation marks (“text”) in the status line.
references to cells	used to express dependency of a value in one cell on values in other cells on the worksheet. Groups of cells can be specified by “intersection,” “range,” and “union” operators.
logical values (true and false)	used in making conditional, “either-or” decisions.
error values	used as substitutes for values that cannot be calculated because of a mistake in a formula. For example, the “result” of division by 0 is an error value.

New values may be calculated by combining other values with the operators, described below under the topics “Numbers,” “Text,” and “References to Cells”; or by using functions, such as MIN or MAX, described in Chapter 10, “Functions.”

The following sections describe each type of value.

Numbers

Numbers may be written as integers (123), as decimal fractions (123.45), or in scientific notation. In the latter case, an integer or decimal fraction (mantissa) is followed by the letter E and a positive or negative integer exponent. This notation multiplies the mantissa of the number by 10 raised to the given power. For example:

- 12.1E2 means 1,210 (12.1×10^2)
- 1E-5 means .00001 (1×10^{-5})
- 1.5E+6 means 1,500,000
(note: + sign may be omitted).

Percentages may be written as numbers followed by % (same as division by 100):

- 15% means .15 (15/100)

Numbers are calculated with 14 digits of precision and a decimal exponent ranging from -63 to +63. This means that the smallest positive nonzero number is:

- $.1 \times 10^{-63}$

and the largest one is:

- $9.99999999999999 \times 10^{+62}$

Mathematical operators are the following:

Operator	Meaning
^	exponentiation. Calculated by the rule: $a^b = \exp(\ln(a)^b)$.
*	multiplication.
/	division.
%	percent. Written after the value and has the same meaning as /100.
+	arithmetic addition.
-	subtraction. May also be used in front of a value to denote "negative."

Number values

Operator precedence is: $-$ (negative value) is evaluated first, then $\%$, then \wedge , followed by $*$ and $/$, then $+$ and $-$ (subtraction), and finally the logical operators described under “Logical Values” below. Parentheses may be used to alter the order in which Multiplan performs the calculation when more than one operator appears in a formula.

Chapter 10, “Functions,” describes Multiplan functions for performing mathematical, statistical, and financial calculations.

Text

Text values

A text value may contain up to 255 characters. Text is written enclosed within double quotation marks (“”). Text may not include double quotation marks as a character. For example:

- “salary =” is 8 characters of text.
- “1.0” is also text, not a number.

Two text values may be concatenated using the $\&$ operator. The result is a text value that consists of the left text immediately followed by the right. For example:

- “\$” $\&$ “1.00” concatenates the text value “\$1.00”

Chapter 10, “Functions,” describes functions that operate on or return text values. In particular:

- $\text{LEN}(T)$ returns the number of characters in a text value.
- $\text{MID}(T,s,c)$ returns a specified part of a text value.

Functions are also provided for converting numbers into text and vice versa. For example:

- $\text{FIXED}(1,2)$ returns the text “1.00”
- $\text{VALUE}(\text{“0.1”})$ returns the number .1

All the functions are described in detail in Chapter 10, “Functions.”

References to Cells

References to cells describe the location of one or more cells on the worksheet. References are the means of access to the values in cells.

A cell reference consists of a row reference and of a column reference, in that order. (You can give cell references by entering the column reference followed by the row reference, but Multiplan stores the reference in row-column order.)

A cell reference indicates the place where a specific row and a specific column intersect.

For example, R4C3 is a reference to the cell at row 4, column 3. Assuming that that cell has the value 5, the result of the formula R4C3+1 is 6.

Cell references and values

	column					
	1	2	3	4	5	
1						
2						
3						
row 4						R4C3 + 1 = 6
5						

Figure 3. Cell Reference Gives Access to a Value

References may be written three ways:

- as an absolute reference
- as a relative reference
- as a name reference

Absolute references

Absolute cell references

An absolute reference consists of the letters "R" and "C" and the actual row number and column number (as illustrated above).

The forms are:

Form	Meaning
Rn	row number n (1-4095)
Cn	column number n (1-255)
Rn:m	all rows from n through m
Cn:m	all columns from n through m

Placing an R form and a C form together denotes the rectangle formed by the intersection of the rows and columns:

Form	Meaning
RnCm	single cell at row n, column m
Rn:mCp:q	a rectangle of cells

Relative references

A relative reference describes the location of another cell in terms of the location of the current cell. ("Current" means the cell that contains the cell reference.) A relative reference gives a direction by "+" for right or down or "-" for left or up and a number indicating how many rows or columns away from the current cell.

Figure 4. Relative Cell Reference

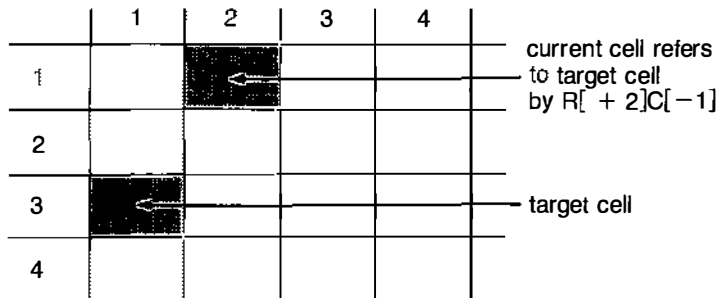

The "target" cell is 2 rows down from the current cell (+ 2) and 1 column left of the current cell (- 1).

The forms of relative references are:

Form	Meaning
R	current row
C	current column
R[+n]	the row that is n rows below R (the + may be omitted)
C[+n]	the column that is n columns to the right of C (the + may be omitted)
R[-n]	the row that is n rows above R
C[-n]	the column that is n columns to the left of C

Hint Avoid extensive use of forward references because they are slower to recalculate. For example, a reference to cell R10C10 from R5C5 is slower than a reference to R5C5 from R10C10.

As for absolute references, placing a relative R form and C form together denotes the rectangle formed by the intersection of the rows and columns. For example:

Form	Meaning
RC[-1]	the single cell just to the left of the current cell

The difference between absolute and relative references becomes apparent only when a reference is copied (see Copy command, Chapter 9, "Commands"). Absolute references will refer to exactly the same cell or cells in all of the copies. The cells referred to by relative references, however, are different for each copy (see Figure 5):

Figure 5. Comparison of Absolute and Relative References

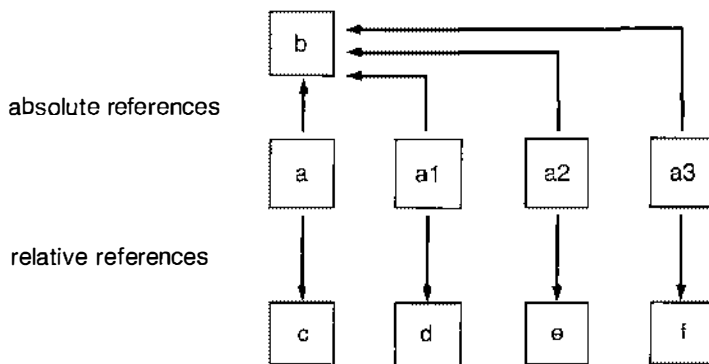

If a reference in cell *a* is absolute and refers to cell *b*, the copied references in cells *a1*, *a2*, and *a3* will all refer to cell *b*.

If a reference in cell *a* is relative and refers to cell *c* as 3 rows down [+3], cell *a1* will refer to cell *d* (not cell *c*), cell *a2* will refer to cell *e*, and cell *a3* will refer to cell *f*.

Names

Names

Names are words used to identify a cell or group of cells. A Name may be defined as an absolute reference with the Name command (see Chapter 9, "Commands"). The spelling rules for names are:

- Names must start with a letter,
- followed by letters, digits, periods, and underline (_) characters,
- up to 31 characters maximum.

Words that are the same as absolute or relative references (for instance, R1C1 or R) must not be used for names.

Once defined, a Name may be used as you would use any absolute reference. For example, you might define the name *Sales* to refer to R3C2:8. The name of the reference suggests that the calculation involves sales figures. The absolute form, R3C2:8, is not mnemonically suggestive of sales figures. However, to the Multiplan program, the meanings are identical.

The name in the example above may be illustrated as:

	1	2	3	4	5	6	7	8
1								
2								
3	Sales							
4								
5								

Figure 6. Names as Cell References

Three operators may be used to combine references: intersection, range, and union.

Intersection Operator (Space)

The intersection operator is used to combine two references to refer to all the cells that belong to both references.

Intersection operators

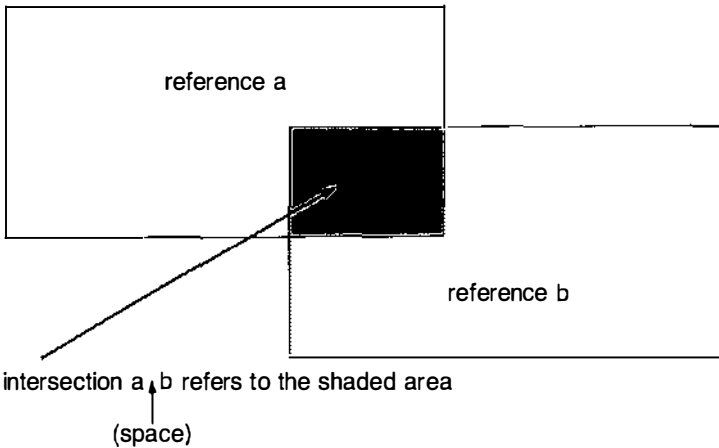
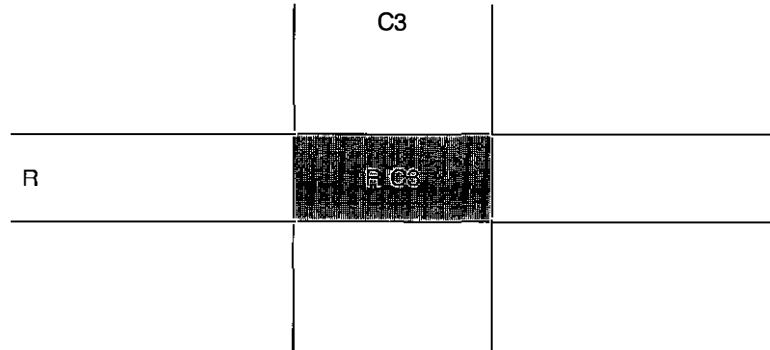

Figure 7. Intersection Reference

R C3
 ↑
 (space)

refers to the cell where the current row and column 3 intersect.

Figure 8. Relative-Absolute Intersection Reference



When reference forms are combined (that is, an absolute with a relative, an absolute with a name, a relative with a name, or a name with a name), the intersection operator must separate them to indicate access to the value or values where the two references intersect.

For example: RC3 is not permitted; write R C3 instead.

If the two references do not intersect, Multiplan returns a #NULL! error value.

Range Operator

Range Operator (Colon) (:)

The range operator is used to combine two references so that the values in a group of contiguous cells may be used.

The area of a range is the smallest rectangle that includes both references.

Typically, in a reference written as a:b, the "a" reference is in the upper left corner and the "b" reference is in the lower right. For example:

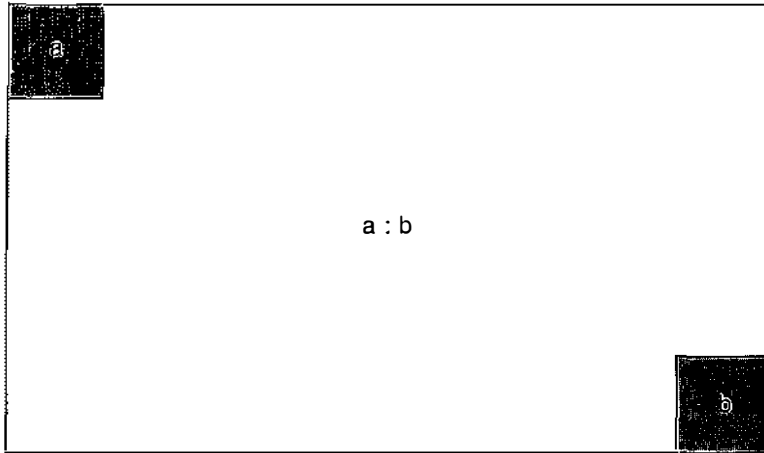

Figure 9. Range Reference

The range operator may be used to combine any of the reference forms (absolute, relative, or name) in any order.

Union Operator (Comma) (,)

The union operator is used to combine references to refer to all cells that belong to either reference. For example:



R1C1,R3C1

Each reference in a union may be any form (absolute, relative, or name), an intersection, or a range.

A union usually refers to cells that are not contiguous. Where a union describes contiguous cells, it describes a rectangle as a range reference would. For example: R1C1,R1C2 equals R1C1:2.

Union operator

Figure 10. Union Operator

Figure 11. Union Operator and Range Reference Similarity



union
R1C1,R1C2



range
R1C1:2

but R1C1,R3C1 does not equal R1:3C1.

Figure 12. Union Operator and Range Reference Difference



union
R1C1,R3C1



range
R1:3C1

The range reference in the second example includes cells not specified by the union reference.

References may be used in formulas that require the value of a single cell. When the reference describes a single cell and a single value is required (for example, R1C1+1), the value meant is the value of the cell described plus the value 1. (Note that this value may be a number, text, logical, or error value, depending on the value in the cell referred to.)

When the reference describes a group of cells but a single value is required, Multiplan chooses the value to be used from the cell where the current row or column intersects the group of cells. In particular, for groups that are parts of rows, Multiplan chooses the value in the current column. Similarly, from parts of columns, the value in the current row is chosen. Figure 13 illustrates a use for this feature. Using a group of cells that is not either a row or a column (or a part of one of these) does not yield useful results.

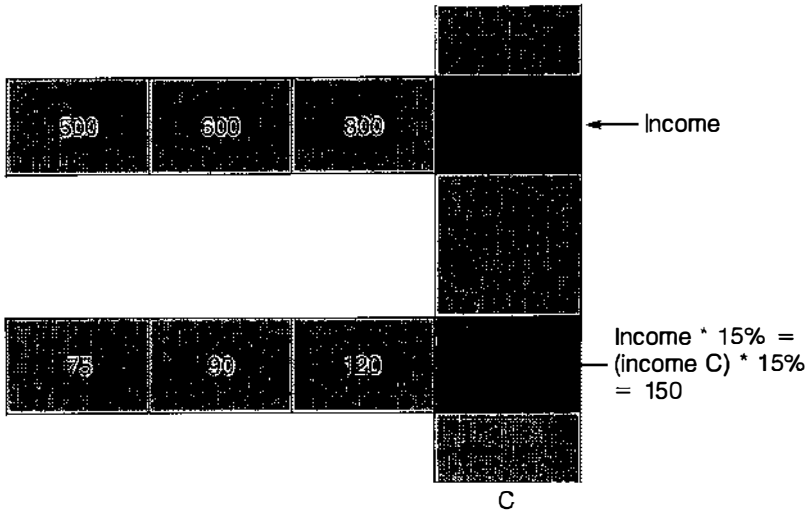

Figure 13. Single Value from a Reference to a Group of Cells

Chapter 10 contains descriptions of the functions that can process a collection of values (SUM(...) for instance). Any type of reference may be given as an argument to such a function. The value of all the cells that are described, whether one or many, will be processed.

Logical Values

The logical values true and false are returned by the comparison operators that compare two numbers:

Logical Values

Operator	Meaning
<	less than
<=	less than or equal
=	equal
>=	greater than or equal
>	greater than
<>	not equal

The functions AND(...), OR(...), NOT(...), TRUE(), and FALSE() also perform logical operations.

The purpose of logical values is to make “either-or” decisions using the IF(...) function. All of these functions are explained in Chapter 10, “Functions.”

Text values (alphas) may also be compared with these operators. The order in which all characters are compared is described under the Sort command in Chapter 9, “Commands.”

Error values

Error Values

When a Multiplan function, operation, or reference is used incorrectly, an error value will result. There are different error values for different error conditions, as described below. Error values “propagate,” meaning that operations or functions that result in error values in one cell cause the same error values in all the cells that refer to the first cell. This also means that when one notices an error value in a cell, the propagation has to be unraveled step by step until the source of the error is found.

For example, we notice that cell R1C1 displays the #NAME? (undefined name) error value. The formula in R1C1 is $a+1$. We check the definition of a using the Name command. We find that the name a is defined to refer to R1C2. That cell is the next step in the search. When we look in cell R1C2, we may find the cause there, but we may also find references to other quantities which will have to be inspected. We may have to look at more than one cell to find the source of the error.

The error values and their causes are:

Value	Cause
#DIV/0!	result of an attempt to divide by 0.
#NAME?	result of an undefined label reference.
#N/A	result when the value is not available. Also, #NA is a special value that may be created using the NA() function and which will be propagated by arithmetic.
#NULL!	result of specifying an intersection of disjoint areas; e.g., R1 R2 (use union instead, R1,R2).
#NUM!	result of overflow (number is too large or too small) or of an illegal use of an arithmetic function; e.g., SQRT(-1).
#REF!	result of a relative reference reaching outside the sheet or of a reference to a deleted area.
#VALUE!	result of using text where a number is needed or vice versa, or of using references when a value is needed.

Files

This section describes how Multiplan uses files, when it reads and writes files, and how links between files are handled.

This information will help you to better plan your use of Multiplan files.

File Handling

Files are permanent repositories of information kept on diskettes. Files are identified by filenames, which are kept in a directory. Multiplan uses files mainly to store worksheets. For more information on diskettes, see the section entitled "Operating Information."

Multiplan can read files, and it can write them. For both operations, Multiplan requires access to the file.

However, the machine may have more than one disk drive and different files may reside on different diskettes. It is important, then, to make sure that the proper diskette is mounted in the proper drive.

If the filename includes a drive specification, then that drive is the proper one. Otherwise, the "default" drive (assigned through the Transfer Options command) is used.

See also the section entitled "Operating Information" and the Transfer Options command in Chapter 9, "Commands," for details.

Efficient operations with multiple diskettes may require some advance planning. Should the planning fail, however, Multiplan will simply display the message:

Enter Y to retry access to *filename*

When you see this message, check the diskette and replace it, if necessary.

The following lists describe when Multiplan reads files, when it writes files, and what problems Multiplan may have with reading and writing files. This information may help you anticipate file access by Multiplan.

Multiplan reads files:

- When a sheet is loaded (Transfer Load command) in any mode (Normal, Symbolic, Other).

Files

File handling

When files are read

- When a sheet is loaded that has supporting sheets, the supporting sheets are read one by one.
- When the eXternal Copy or eXternal Total commands are executed, the source sheet is read.
- When the eXternal Use command is executed, the affected copies are redone, and the source sheets are read. (See the eXternal Use command in Chapter 9, "Commands.")
- The Multiplan system diskette will be read for parts of the Multiplan program when commands are executed and for the Help file when Help is requested.

When files are written

Multiplan writes the file to the diskette:

- When a sheet is saved (Transfer Save command) in any mode.
- When a sheet is renamed or deleted, the file directory is read or written. The file directory, by definition, shares the diskette with the worksheet files.
- When the Print File command is executed.
- When sheet linking relationships change, a Transfer Save or Transfer Rename command, in addition to normal duties, gains access to all supporting sheets to issue or to revoke receipts.
- When you execute the Quit command, a file titled MP.INI is saved.

Problems with file access

Problems with File Access

You should be aware of problems to consider when trying to read or write a file. If problems with file access persist, check for possible causes from the following lists.

Problems when reading:

- The information may not be on the diskette. Use the Transfer Load command and the direction keys to display the directory of files on the diskette.
- The information is not reliably readable or is unreadable. You should maintain backup copies of important files.
- The information is not in the expected format. Check the "mode" setting of the Transfer Options command. Remember that the eXternal Copy command requires that sheets be saved in Normal mode.
- The information is not up to date. This may happen if incorrect procedures are used for updating a collection of externally linked sheets. See the section below, "External Relationships," for details.

Problems when reading

Problems when writing:

- The diskette may become filled. Diskettes can store only a limited amount of information. As more files are stored on them, they may fill up. See the section entitled "Operating Information" for procedures for determining the amount of storage used on a diskette.
- Previous information stored in a file may be valuable. Multiplan will display the message:

Enter Y to overwrite file

Pause and reflect if this is what you want.

- The diskette may be write-protected. Consider the reason for write-protection before changing it.
- Errors during writing, such as an interruption, may leave incorrect information on the diskette. Make sure that write operations are allowed to complete.

Problems when writing

External Relationships

The information in this section applies to the eXternal group of commands. Refer to the discussion of these commands in Chapter 9, "Commands," for additional information.

External relationships between worksheets may be illustrated as follows:

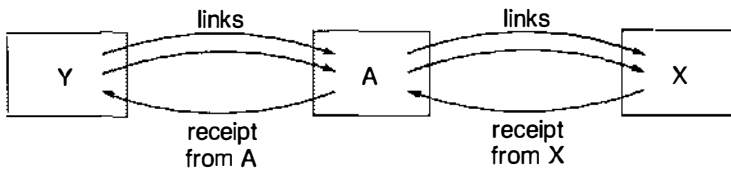

External relationships

Figure 14. External Relationships between Worksheets

	Active Sheet	
Sheets depending on Y	Sheets supporting A	Sheets supporting X
A	Y	A
	Sheets depending on A	
	X	

The set of external links can be reviewed by stepping through the supporting sheet names and the source and target areas in the eXternal Copy command.

Changing data on a supporting sheet has no immediate effect on its dependent sheets. Only when a dependent sheet is loaded is the current information read from its supporting sheet. Thus, when changes are made to sheet Y, nothing changes on sheet A until sheet A is loaded. When sheet A is loaded, then sheet Y is read, and its data is copied to sheet A.

Similarly, when sheet A is changed (including changes from sheet Y), sheet X does not change until it is loaded. When sheet X is loaded, then sheet A is read, and its data is copied to sheet X.

Note that for the information read from A to X to be current with the information on Y, A must have been loaded *and saved* at least once before X was loaded. Information is copied only one link at a time.

In a more complex set of worksheets, the relationships between the worksheets may be unraveled using the eXternal List command on each sheet and creating a dependency diagram similar to the one above.

Consistency of all data can be assured by starting with a set of sheets that are not supported by any sheets. Load and save a second set of sheets that depend on the set of unsupported sheets, then load and save sheets that depend on the second set of sheets, and so on until all sheets have been loaded and saved.

This process is illustrated in the following diagram:

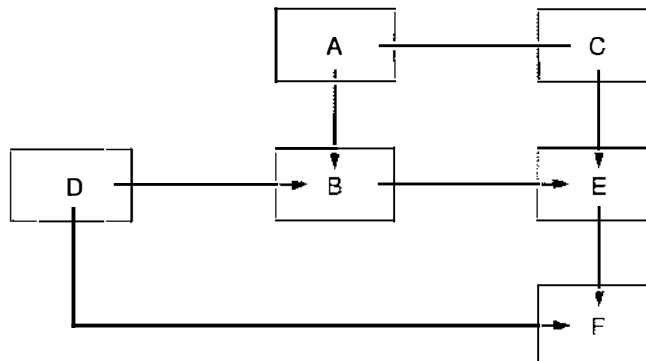

Figure 15. Dependency Diagram

Sheets A and D are not supported by any other sheets. If the information on them is current, then:

- 1 Load and save sheets C and B.
- 2 Load and save sheet E.
- 3 Load and save sheet F.

When preparing the dependency diagram, remember that the list of “depending sheets” on each sheet is not necessarily complete. For example, the listing of sheets depending on A is contingent on a “receipt” being issued when the link was established by B.

A “receipt” is an entry in the supporting file that says sheet B receives data from this sheet. When you give the eXternal List command, Multiplan looks at the receipts to build the list of “Sheets depending on.” The “receipt” must have been written correctly onto A just after B was saved. If, for any reason, Multiplan cannot enter the receipt onto sheet A, the “depending” list on A is not current. Even so, the data from the supporting sheets can be copied as specified by the eXternal Copy command.

The list of “supporting” sheets will always be correct.

Receipts

Transforming the Worksheet

The information in this section applies to the Delete, Insert, Move, and Sort commands. Refer to the discussions of these commands in Chapter 9, “Commands,” for additional information.

When rows or columns are inserted, deleted, moved, or sorted, sections of the worksheet may be displaced. For example:

- One column is inserted before column 2. This moves the part of the worksheet that is to the right of column 2 one column farther to the right.
- Row 2 is moved to before row 10. Besides moving the contents of row 2 to row 9, the former rows 3 through 9 are displaced one row toward the top of the sheet.

Transforming the worksheet

Because these commands may change the location of cells, Multiplan also automatically adjusts any references to the cells, whether they occur in formulas or in the definition of names. However, the adjustments to some references after the worksheet has been transformed may cause problems. The problems fall into the following general categories:

Problems with cell movements

- References to cells that have been deleted from the sheet are replaced by #REF! error values. All formulas that contained the references must be edited. These formulas are found by inspecting the cells that display the #REF! error value.
- If the reference is to a group of cells and the transformation would distort a rectangular part of the group into a more complex shape (for example, if a corner cell is deleted from a rectangular area), the name definition is not changed.
- If cells are inserted adjacent to a group of cells, references to the group are not updated to include the new cells. If the enlargement of the group is desired, the insertion must be made into the interior of the group rather than at the boundary. If necessary, the new cells may be inserted at an unambiguous place (e.g., in the interior of the group), then the cell contents copied as required.
- Related problems may occur when rows or columns containing a boundary of a group are moved. Such moves will “drag” the boundary line of the definition of the group along. If this is not desired, the move can still be accomplished by an insert, copy, delete sequence.
- If a formula is copied into a number of cells using the Copy Down, Copy Right, or Copy From commands, the relative references in all of the formulas are adjusted equally. The model formula for the adjustment is the first one encountered on the sheet. This means, for example, if the formula $R[-1] * 1.05$ is copied from R1C2 to R1C14, and if column 5 is deleted, all formulas will be adjusted according to R1C2; no change in this case. However, if column 1 is deleted, the reference in R1C2 will become #REF! (see the first rule above), and the other formulas will follow accordingly. To fix undesirable results, edit the model formula and recopy it.

Note that the Sort command may move many rows and, therefore, may cause any of these problems.

Using Worksheets from Other Programs

If you or your co-workers have created worksheets using Visicalc, Lotus 1-2-3, or Lotus Symphony, you can work on these worksheets in Multiplan. When you load a worksheet created by one of these other programs, Multiplan automatically translates the other program's worksheet format into Multiplan format. After working on any worksheet, you can save it in Multiplan or 1-2-3 format.

There are a few Lotus features that aren't fully loaded or saved; these are described in detail in the following sections.

You may want to use the following procedure, rather than the CONVERTD program, for loading Lotus 1-2-3, Symphony, or Visicalc files into Multiplan. Before you use the following procedure, you should be familiar with choosing commands and specifying files that you want to load, discussed in Part 1 of this manual, "Using Multiplan."

Loading Other Worksheets

To load a Visicalc, 1-2-3, or Symphony file into Multiplan:

- 1 Choose the Transfer Options command.
- 2 In the "mode" field, choose Other.
The Other option tells Multiplan to recognize Visicalc, 1-2-3, or Symphony formats when you load files.
- 3 Press ENTER.
- 4 Choose the Transfer Load command.
- 5 In the "filename" field, type the name of the file you want to load, including its extension. For a 1-2-3 file, for example, you would type *filename.wks*
- 6 Press ENTER.

Multiplan loads your file and displays it on the screen in Multiplan format.

Multiplan will not load some of 1-2-3's functions. For example, Multiplan will not load 1-2-3's date function, because Multiplan doesn't use dates. There are also some restrictions when you use macros.

Multiplan treats Symphony files the same way it treats 1-2-3 files. If you're a Symphony user, you can use the following notes.

Loading other worksheets

When your 1-2-3 file contains functions or macros, you don't need to modify it before loading it into Multiplan; you just need to be aware of the few features that have limitations. The following paragraphs describe how Multiplan treats these limitations when encountered in your file.

Notes on loading 1-2-3 Files:

Columns Any data in columns 256 or higher of a 1-2-3 file will be lost when you load it into Multiplan, because Multiplan worksheets have a maximum of 255 columns.

Cell Formatting for Text The default cell format for text in 1-2-3 cells is "continuous," so all text in the cell is shown. In Multiplan, the default cell format is "general;" if text in a cell is wider than the width of the cell, part of the text is hidden.

1-2-3 cells loaded into Multiplan may be hidden if your Multiplan cell format is set to "general." The information is not lost. To display hidden text, set the "format code" field in the Format Cells command to "Cont" (continuous) for the affected cells.

Macros Multiplan does not translate 1-2-3 macros into Multiplan worksheet format. It does, however, treat 1-2-3 macros as text and loads them along with your file. You cannot use the macros within Multiplan. If you save the same file back to 1-2-3 format, however, you will then be able to use the macros again in 1-2-3. See "Saving Worksheets in 1-2-3 Format," in this section, for more information.

Functions Multiplan deletes 1-2-3 formulas that contain the following functions, but keeps the value in the formula's cell:

@ACOS	@DSTD
@ASIN	@DSUM
@ATAN2	@DVAR
@CHOOSE	@HLOOKUP
@DATE	@MONTH
@DAVG	@MONTH
@DAY	@RAND
@DCOUNT	@VAR
@DMAX	@YEAR
@DMIN	

Multiplan treats Symphony functions not shared with 1-2-3 the same way it treats the functions listed above.

Saving Worksheets in the 1-2-3 Format

In Multiplan, you can save worksheets in 1-2-3 format in the same way you would save files in the Multiplan format. When you save your worksheet, Multiplan automatically translates it into 1-2-3 format.

To save a worksheet in 1-2-3 format:

- 1 Choose the Transfer Options command
- 2 In the "mode" field, choose Other.
Other tells Multiplan to save your worksheet as a 1-2-3 file.
- 3 Press ENTER.
- 4 Choose the Transfer Save command.
- 5 In the "filename" field, type a file name for your worksheet, including the 1-2-3 ".wks" extension. Without this extension, 1-2-3 will not recognize your file.
- 6 Press ENTER.

Multiplan saves your file in the 1-2-3 format.

Multiplan will not save a few functions in the 1-2-3 format. For example, Multiplan will not save the MIRR function, since 1-2-3 would not recognize it. You also have some restrictions using Multiplan macros in 1-2-3.

When your Multiplan file contains functions or macros, you don't need to modify it before saving it in the 1-2-3 format; you just need to be aware of the few features that have limitations. The following paragraphs describe how 1-2-3 treats these limitations when it encounters them in your file.

Notes on Saving Multiplan Files in the 1-2-3 Format:

Rows Any data between rows 2049 and 4095 of a Multiplan worksheet will be lost when saving in the 1-2-3 format, because 1-2-3 (version 1A) has a maximum of 2048 rows.

Macros 1-2-3 will not translate Multiplan macros into 1-2-3 format. When you load the worksheet, 1-2-3 treats the Multiplan macros as text. You cannot use the macros in 1-2-3. If you ever load the same file back into Multiplan however, you will then be able to use the macros. See "Loading Other Worksheets," above, for more information.

Functions When saving in the 1-2-3 format, Multiplan deletes any of its formulas that contain the following functions, but saves the value in the formula's cell:

Saving a worksheet in 1-2-3

COLUMN	MIRR
DELTA (Iteration function)	NPER
DOLLAR	RATE
FIXED	REPT
INDEX	ROUND
ITERCNT (Iteration function)	ROW
LEN	SIGN
LOOKUP	VALUE
MID	

9 Commands

The following directory explains each Multiplan command.

At the beginning of each command description, the complete menu for the command or subcommand is shown with proposed responses. In most cases, the proposed response is derived from the position and contents of the active cell. For consistency of reference, a general notation is used for proposed responses, as follows:

- RC indicates the active cell
- R indicates the row number of the active cell
- C indicates the column number of the active cell
- W indicates the active window
- () indicates a description of the proposed response; for example, (contents of RC)

Other proposed responses, usually numbers, are shown as they appear when the command is used.

The examples provided are intended to give you a sample of the uses for the command. A short description of the action to be performed precedes a command format with proposed responses in the fields. To recreate the example yourself, use any of the methods for entering responses until your command line looks like the example.

All commands are terminated (carried out) by pressing the RETURN key.

Related and similar commands are listed under the heading "See Also." Commands that offer subcommands are described only generally under the main command heading. Refer to the subcommand descriptions for the details of performing a particular action.

Hint Perform similar operations together. Try to define all names at once. Copy all cells at once. Many Multiplan commands offer you proposed responses. By performing similar operations together, you can make maximum use of the proposed responses, which saves considerable time. Also, position the cell pointer before selecting a command. This makes it easier to use proposed responses.

Alpha

Alpha

ALPHA: (cell contents)

Enter text

Places text in the active cell. If the active cell already contains text, that text is the proposed response to the Alpha prompt.

The proposed response may be edited, but if you simply begin typing, the proposed response is replaced entirely.

The Alpha command is terminated by pressing the RETURN key or any action key that moves the cell pointer, such as the direction keys.

The contents of a cell containing text are displayed in double quotation marks in the status line. Multiplan supplies these double quotation marks automatically.

Alpha may not be used to blank a cell. Use the Blank command for this.

The Alpha command is highlighted in the command menu when Multiplan is idle. This means that (1) Alpha can be selected by pressing RETURN; and (2) if RETURN is pressed inadvertently, you may find yourself in the Alpha command.

Entering text or values in successive cells is made easier because of the following feature:

If either the Alpha or Value command is terminated by an action key that moves the cell pointer, the cell pointer is moved appropriately, and Multiplan displays on the command line:

ALPHA/VALUE:

enter text or value

The first character typed selects the standard Alpha or Value command. The Value command is selected if you press one of the digits 0-9 or one of the characters = (equals), + (plus), - (minus), . (period), ((left parenthesis), or " (quotation mark). The characters selecting the Value command have the same effect as when selecting from the main command menu. This effect is described under the Value command in this chapter. All other characters select the Alpha command.

This process can be repeated for entering text, numbers, and formulas in successive cells, until the RETURN or CANCEL key is pressed.

Examples

To enter the text "Net Profit" into the active cell:

ALPHA: Net Profit

To enter the text *Spencer*, the text *Sales*, and the number *1000* in adjacent cells, press A (for Alpha), type *Spencer*, press the RIGHT direction key, type *Sales*, press the RIGHT direction key, type *1000*, and press RETURN.

Hint Simply press the RETURN key to select the Alpha command whenever the main command menu is displayed.

See Also

Format Cells to permit the display of cell contents to cross a cell boundary.

Format Width to accommodate text within a column.

Name to create names for cells.

Value to enter numbers and formulas.

Blank

Blank

BLANK cells: **R1C1**

Enter reference to cell or group of cells

Replaces contents of specified cells with blanks. The proposed response permits quick blanking of the active cell.

The format of the cell is not changed. The cell is still available for storing values.

Names are not affected. If a cell was Named before the Blank command was used, that name will still apply.

When a formula refers to a blank cell, its number value is taken as zero, or its text value is a blank.

Examples

To blank the cell in row 3, column 2:

BLANK cells: R3C2

To blank all cells in the area named Sales:

BLANK cells: Sales

To blank an irregular area:

BLANK cells: R1:6C1,R7:8

See Also

Delete to remove cells from the sheet entirely.

Transfer Clear to clear the entire sheet.

Copy

Copy

COPY: Right Down From

Select option or type command letter

Presents a choice of ways to copy some cells into other cells. Both the contents and the formats of the source cells are copied.

Source cells are not altered.

- Copy Right copies one cell or a column of cells into cells to its right.
- Copy Down copies one cell or a row of cells into cells below it.
- Copy From is the general form and can be used for all copying on the active worksheet. Copy Right and Copy Down are included because they make a common copying task easier.

The subcommands are explained individually below.

Hint Use the Copy commands for filling in cells with identical values, especially formulas, but also numbers and text. Copying is simpler, less error prone, and more space efficient than manually entering repeated values into cells individually.

See Also

Insert to add new cells between existing ones.

Move to move cells to other locations.

eXternal Copy to copy cells from an inactive worksheet.

Copy Down

Copy Down

COPY DOWN number of cells: starting at: R1C1

Enter number

Copies the specified cell the number of times specified in the “number of cells” field into the cells below it.

The proposed response for the “number of cells” field is the number used in the last Copy Down or Copy Right command. The total number of identical cells will be the number specified plus one (for the original).

The command can also copy down a row of cells by specifying a row or part of a row in the “starting at” field.

Examples

To copy the value and format of R1C1 into the ten cells below it:

COPY DOWN number of cells: 10 starting at: R1C1

To copy the first five cells in row 1 into the next four rows below:

COPY DOWN number of cells: 4 starting at: R1C1:5

Copy From

Copy From

COPY FROM cells: **R1C1** to cells: R1C1

Enter reference to cell or group of cells

Copies the contents of a cell or group of cells to another location on the sheet. Copy From is used, for example, when the source cells and the destination cells are not in the same row or column.

When there is only one source cell, the cell contents are copied into each destination cell.

When the source is a group of cells, the entire group is copied. When only one destination cell is given but the source is a group of cells, the destination cell marks the upper left corner of the destination area.

In general, either the source or the destination should consist of a single cell.

In special circumstances, copying vectors can be accomplished. (A vector is a line of two or more cells, either in a row or in a column.) Copying from a row to a row or from a column to a column is allowed if the source and the destination are the same size. If copying is done from a row vector to a column vector, or from a column to a row, the resulting copy is a rectangle in which the source vector is copied starting at each cell of the target vector.

The following diagrams illustrate the results of copying vectors, as described above:

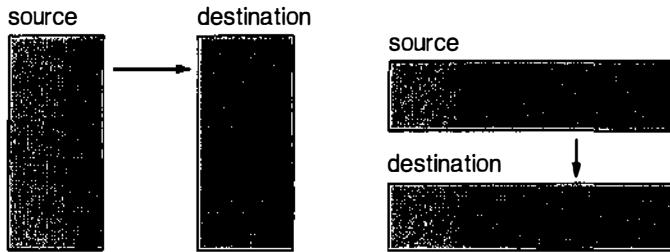
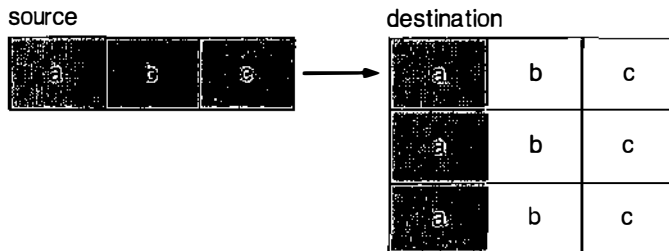
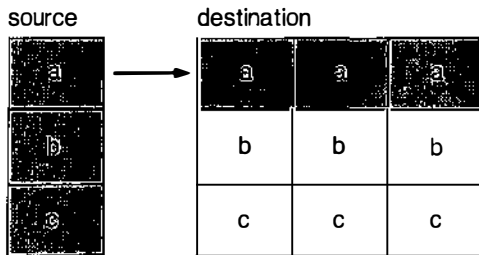

Figure 16. Results of Copying Vectors



If other forms of copies are attempted, the system cancels the copy command and displays the "Illegal parameter" message.

Examples

To copy the contents of cell R1C1 into cell R5C3:

COPY FROM cells: R1C1 to cells: R5C3

To copy the contents of cell R1C1 into all cells in column 8:

COPY FROM cells: R1C1 to cells: C8

The command can also copy right a column of cells by specifying a column or part of a column in the “starting at” field.

Examples

To copy the contents of the active cell (R1C1) into the eight cells to the right of it:

COPY RIGHT number of cells: 8 starting at: R1C1

To copy the contents of the five cells in column 1 (R1:5C1) into column 2, giving two side-by-side columns with the same contents:

COPY RIGHT number of cells: 1 starting at: R1:5C1

Delete

DELETE: Row Column

Select option or type command letter

Presents choices for deleting cells from the worksheet and closing up the space.

- Delete Row deletes a row or rows and moves the rest up.
- Delete Column deletes a column or columns and moves the rest to the left.

Multiplan adjusts all references affected by any deletion. See “Transforming the Worksheet” in Chapter 8, “Elements of Multiplan,” for the description of how the Delete command affects references.

The subcommands are explained individually below.

See Also

Blank to make cells empty.

Delete

Delete Column

Delete Column

```
DELETE COLUMN # of columns: 1 starting at: 1
                between rows: 1 and: 4095
Enter number
```

Deletes all or part of a column or columns. The proposed response for the starting column is the column of the active cell. This command is most commonly used to delete complete columns by accepting the proposed responses of rows 1 and 4095.

Columns to the right of the deleted columns move left, and new columns of blank cells are added at the right edge of the sheet.

Parts of columns can be deleted. The deletion takes place between the specified rows; other rows are not affected.

Examples

To delete the entire column 4:

```
DELETE COLUMN # of columns: 1 starting at: 4
                between rows: 1 and: 4095
```

To delete a rectangular area in columns 3 and 4, between rows 3 and 8:

```
DELETE COLUMN # of columns: 2 starting at: 3
                between rows: 3 and: 8
```

The portion of the worksheet in rows 3 through 8 which was to the right of column 4 will move two columns to the left.

Delete Row

Delete Row

```
DELETE ROW # of rows: 1 starting at: 1
                between columns: 1 and: 255
Enter number
```

Deletes all or part of a row or rows. This command is most commonly used to delete complete rows by accepting the proposed responses of columns 1 and 255.

Rows below those deleted move up, and new rows of blank cells are added at the bottom of the sheet.

The proposed response for the starting row is the row of the active cell.

Parts of rows can be deleted. The deletion takes place between the specified columns; other columns are not affected.

Examples

To delete the active row (R1):

```
DELETE ROW # of rows: 1 starting at: 1
                between columns: 1 and: 255
```

To delete a rectangular area in rows 6 and 7 between columns 1 and 8:

```
DELETE ROW # of rows: 2 starting at: 6
                between columns: 1 and: 8
```

The portion of the worksheet in columns 1 through 8 which was below row 7 moves up two rows.

Edit

Edit

EDIT:

Enter formula

Used to edit a formula or value in the active cell. If you edit text with the Edit command, remember to enclose the text in double quotation marks.

The current contents are shown in the command line. The edit cursor is placed at the end of the current contents.

After you have edited the cell's contents, press RETURN or one of the cursor movement keys, such as a direction key, to put the contents into the cell. If you use a cursor movement key to place the contents in the cell, Multiplan changes to the ALPHA/VALUE: command rather than returning to the main command menu. Refer to the description under the Alpha command.

Press CANCEL before pressing either RETURN or one of the cursor movement keys to cancel your changes and to return to the main command menu.

If the cell contains a formula, Multiplan checks the formula for errors when RETURN is pressed. If the formula contains an error, the erroneous part is highlighted, and the Multiplan Edit command remains active.

See the "Editing" section in Chapter 8, "Elements of Multiplan," for the description of the editing keys.

See Also

Alpha for entering or editing text.

Format

Format

FORMAT: Cells Default Options Width
Select option or type command letter

Presents a choice of various display adjustments.

- Format Cells alters the alignment and format of a cell or group of cells.
- Format Default sets the default alignment, format, and width for all cells.
- Format Options controls the display of formulas and of commas in numbers.
- Format Width sets the width of a column or columns.

The display of cell contents is controlled by the settings in the "alignment" and "format" fields of the Format Cells command.

The setting in the “alignment” field controls the placement of the contents within the available spaces of the cell; whether the empty space is placed to the right of the contents, to the left, or on both sides.

The setting in the “format” field, together with the response in the “# of decimals” field, controls how the value is displayed, as a dollar amount, as a percentage, as a decimal value, and so on.

In both the “alignment” and “format” fields, there is a “Default” setting. The “Default” setting is defined by the Format Default Cells command. The settings selected in the “alignment” and “format” fields of the Format Default Cells command define the display of all cells with the “Default” setting.

All cells have the “Default” setting initially. (When Multiplan is first started, the display is controlled by “General” alignment and “General” format.) If you insert new rows or columns, the inserted cells receive the default setting.

The format given to the default settings can be changed at any time by using the Format Default command. This allows you to change easily the format of all cells that have the default code setting, which may be most of the cells.

We recommend that you define the most common format you will be using as the default, and alter a cell or some cells to display their contents differently from the default with the Format Cells command.

The subcommands are explained individually below.

Hint To save time, format entire rows or columns at one time, except for “Continuous” format. Formatting entire rows or columns does not extend your worksheet.

See Also

Print Margins to set the format of a printed copy of the sheet.

Format Cells

Format Cells

FORMAT cells: **XXXX** alignment:(Def)Ctr Gen Left Right -
 format code:(Def)Cont Exp Fix Gen Int \$ * % - # of decimals: 0
 Enter reference to cell or group of cells

Alters the alignment and format codes of one or more cells.

The proposed responses are the format codes of the active cell. This command may be used to review the settings for the active cell. The settings of the active cell may be given to a group of cells by changing the response in the “cells” field.

If you are changing the alignment code of a group of cells but not the format code, you must select the minus sign response in the “format code” field to keep the format codes as they are. Otherwise, all cells in the group will receive the format code of the menu setting.

Similarly, if you want to change the format code but not the alignment code of a group of cells, select the hyphen response in the “alignment field.”

The alignment codes are:

Alignment codes		Actions
Def	Default	Align this cell by the default alignment.
Ctr	Center	Center the cell display in the column.
Gen	General	Align text left, numbers right.
Left	Left	Left-justify the cell display in the column.
Right	Right	Right-justify the cell display in the column.
--	(minus sign)	Leave all alignment codes as they are. Used when changing the format code of a group of cells but not the alignment codes.

Text is displayed only for the width of the cell unless the Continuous format code is selected.

The format codes are:

Format codes		Actions
Def	Default	Display this cell with the default format.
Cont	Continuous	Text longer than the column width is displayed at its full width, crossing into the column on the right if necessary (the cell to the right must be blank and must have the Continuous format also). Numbers are displayed in the General format code. Typically, you will want to format an entire row when using the Continuous format code.

Hint Use the “Continuous” cell format code sparingly. Formatting whole rows with “Continuous” format or specifying “Continuous” as the default setting is expensive.

Exp	Scientific	Numbers are displayed as a decimal notation times a power of ten; for instance, 2.1E6 for 2100000. The number of decimal places used is set in the “# of decimals” field of the Format Cells command.
Fix	Fixed point	Numbers are displayed rounded to a fixed number of digits of decimal fraction. The number of decimal places is set in the “# of decimals” field of the Format Cells command.
Gen	General	Numbers are displayed as precisely as possible in the available width of the cell, with scientific notation used automatically, as needed.
Int	Integer	Numbers with a decimal fraction are rounded to integers.
\$	Dollar	Money amounts are displayed with a leading dollar sign and two decimal places. Negative numbers are shown in parentheses.
*	Bar graph	<p>When the cell contains a number, it is rounded to an integer and that many asterisks are displayed. For example, all values between 2.5 and 3.5 are displayed as three asterisks.</p> <p>Use the Bar graph format code to build a bar graph. Negative numbers are shown in parentheses. Only as many asterisks as the cell width allows are shown. To see all asterisks, use the Format Width command to widen the cell. See also the REPT function for creating bar graphs composed of other characters.</p>
%	Percent	Numbers are displayed as a percentage. The number of decimals is set in the “# of decimals” field of the Format Cells command. For example, the value .1 will be displayed as 10% if the # of decimals is zero; or as 10.0% if the # of decimals is 1.
-		Leave all format codes as they are. Used when changing the alignment code of a group of cells but not the format codes.

The “# of decimals” field is used only for the “Fix”, “Exp”, and “%” format codes. If you enter a response to this prompt for the other format codes, your response is ignored. If you are not specifying one of these three format codes, you can simply press RETURN after specifying the format code.

Examples

To align the contents of the active cell (R5C15) in the center of the available spaces:

```
FORMAT CELLS: R5C15          alignment: Def(Ctr)Gen Left Right -
format code:(Def)Cont Exp Fix Gen Int $ * % - # of decimals:0
```

To display the cells in column 2, rows 3 through 6 as money values preceded with a dollar sign and displayed with two decimal places:

```
FORMAT CELLS: R3:6C2          alignment:(Def)Ctr Gen Left Right -
format code: Def Cont Exp Fix Gen Int($)*% - # of decimals:0
```

Notice that the alignment of all cells in this group is now “Default.” If any of the cells had an alignment setting other than “Default” and if you want to preserve the special alignment, select the hyphen instead of the “Def” response in the “alignment code” field.

To display the values in rows 1 through 12 of column 10 as percentages with up to four decimal places accuracy:

```
FORMAT CELLS: R1:12C10       alignment: Def Ctr Gen Left Right(-)
format code: Def Cont Exp Fix Gen Int $ *(%) - # of decimals:4
```

Any alignment already specified for any of the cells in this group is retained.

Hint To copy quickly the format of a group of cells into another part of the worksheet, first copy the group of cells as they are. Then, blank the cells in the new area.

See Also

Format Default to set the default format.

Format Width to set the width of specific columns.

Format Default

FORMAT DEFAULT: Cells Width

Presents a choice of two kinds of defaults to be changed.

- Format Default Cells sets default alignment and format codes.
- Format Default Width sets the default width of all columns.

See Also

Format Cells to alter the format and alignment codes of specific cells.

Format Width to alter column widths of specific columns.

Format Default

Format Default Cells

FORMAT DEFAULT CELLS alignment: Ctr (Gen) Left Right
format code: Cont Exp Fix(Gen)Int \$ * % # of decimals: 0

Sets the alignment and format for all cells that have the default setting. The initial default alignment and format code is General.

The alignment and format codes are listed and described under the Format Cells command.

Example

To set the default format code to money amounts (\$):

FORMAT DEFAULT CELLS alignment: Ctr (Gen) Left Right
format code: Cont Exp Fix Gen Int(\$) * % # of decimals: 0

Format Default Cells

Format Default Width

Format Default Width

FORMAT DEFAULT width in chars: **10**

Enter number

Sets the width of all columns that have the “default” width setting. See *Format Width* for an explanation of default width.

The initial default width is 10 characters.

Example

To set the default width to 12:

FORMAT DEFAULT column width in chars: 12

See Also

Format Width to alter the width of some columns.

Format Options

Format Options

FORMAT OPTIONS commas: Yes formulas: Yes(No)

Select option or type command letter

The proposed responses are the current settings of the options.

For cells that have “Fix,” “Int,” “\$,” or “%” format settings, the comma option groups a number into thousands and separates the groups with commas. For example, a number such as 12345678 under the comma option would be displayed as 12,345,678.

The formulas option permits you to see what generates the value in every cell. A cell normally displays the value of a formula placed in it. Selecting “Yes” for the formulas option causes cells that contain formulas to display their formulas instead of their values. The width of all columns is doubled. Cells that contain text display their contents in double quotation marks.

When the “formulas” option is off (No), check the formula in a cell by using the Edit command or by moving the cell pointer to the cell; the formula will appear in the status line.

Example

To display formulas in the cells that contain them:

```
FORMAT OPTIONS commas: Yes(No) formulas:(Yes)No
```

Format Width

Format Width

```
FORMAT WIDTH in chars or d(default): 8 column: 1 through: 1
```

Enter number, or d for default

Alters the width of one or more columns to the number of characters specified.

The proposed response for the “in chars or d(efault)” field is always d. “d” is a special “default” setting, similar to the default setting for format and alignment codes. When the width setting is “d”, the column width is controlled by the Format Default Width command.

All columns have the default setting initially. The width of all columns with the default setting can be changed easily using the Format Default Width command. You can set the most convenient width as the default with the Format Default Width command, and alter specific columns to other widths with the Format Width command.

If a cell contains text longer than the column is wide, Multiplan cuts off the display at the right edge of the column. Use this command to widen the column or the “Continuous” cell format.

If a cell contains a number that cannot be displayed in the column width, Multiplan displays a series of number signs (#) instead. This can be fixed by widening the column, or sometimes by using a different format code.

Examples

To change the width of column 1:

```
FORMAT WIDTH in chars or d(default): 12 column: 1 through: 1
```

To change the width of columns 4 through 8 to twenty characters:

```
FORMAT WIDTH in chars or d(default): 20 column: 4 through: 8
```

See Also

Format Cells to set Continuous format code.

Format Default Width to set the default column width.

Goto

Goto

GOTO: Macro Name Row-col Window

Select option or type command letter

Presents a choice of ways to move the cell pointer to a new position.

- **Goto Macro** runs the specified macro.
- **Goto Name** makes the first cell of a named area the active cell.
- **Goto Row-col** makes the specified cell the active cell.

If a requested cell is already visible through the active window, only the cell pointer is moved.

If the requested cell is not visible through the active window, the active window is shifted so that the named area appears in the specified window.

- **Goto Window** makes the specified cell the active cell and places it at the upper left corner of the specified window.

The subcommands are explained individually below.

Hint Use primitive forms of reference wherever possible. For example, it is more efficient to use R2C2 than R2 C2; or R1:2C1 than R1C1:R2C1.

Goto Macro

Goto Macro

GOTO macro:

Enter reference to cell or group of cells

Runs the macro you specify.

You can enter the name of the macro directly or use the direction keys to step through the list of named macros in the worksheet. This field will also accept a cell reference.

Example

To run a macro named *bossformat*, which begins in the cell located at R200C20:

GOTO macro: bossformat

or

GOTO macro: r200c20

Goto Name

Goto Name

GOTO name:

Enter reference to cell or group of cells

Places the cell pointer on the upper left corner cell of the named area, making that cell the active cell.

Use the direction keys to step through the list of names.

Example

To move the cell pointer to the upper left corner of the area named SumCosts:

GOTO name: SumCosts

C

Goto Row-col

Goto Row-col

GOTO row: column: 1

Enter number

Places the cell pointer on the specified cell, making that cell the active cell.

Examples

To move to row 25 in the active column (column 1):

GOTO row: 25 column: 1

The proposed response in the "column" field was not changed.

If rows 1 thorough 20 are visible through the window when you enter this command, the window will be shifted so that cell R25C1 is visible in the upper left quarter of the active window.

To make row 37, column 9 (R37C9) visible:

GOTO row: 37 column: 9

Goto Window

Goto Window

GOTO WINDOW window number: row: 1 column: 1

Enter number

Places the specified cell in the upper left corner of the window specified.

If you use this command with the proposed responses, which are the active window and active cell, Multiplan redraws the active window, placing the active cell in the upper left corner.

Examples

To set the active cell as the upper leftmost cell of window #3:

GOTO WINDOW window number: 3 row: 5 column: 15

To set cell R100C45 as the upper leftmost cell of window #5:

GOTO WINDOW window number: 5 row: 100 column: 45

See Also

Window Split to open windows.

Help

HELP: Resume Start Next Previous
 Applications Commands Editing Formulas Keyboard
 Select option or type command letter
 R1C1 100% Free Multiplan: TEMP

Help

Provides helpful information about Multiplan.

Help information is read from a diskette file. Information in the Help file is requested two ways: either (1) selecting Help from the main command menu, or (2) pressing the HELP action key, except when using the Alpha command (this places a question mark as a response to Alpha). When you request Help, the worksheet is replaced by text from the Help file, and the Help command menu appears.

The worksheet display resumes when you either select the "Resume" subcommand (press R or RETURN) or press CANCEL. "Resume" returns to the exact place where Help was requested. CANCEL returns to the main command menu.

The information displayed depends on when Help is requested. In particular:

- If you use SPACE or BACKSPACE to highlight a command word in a menu, a description of that command is shown when you request Help.
- If the edit cursor is in a command field, a description of that field is shown.
- If the message line shows an error message, either a description of the previous command or a description of the error is shown.

Once in the Help command, you can request Help information by selecting one of the following options on the Help menu:

Option	Result
Resume	Returns to the menu where you requested Help.
Start (or HOME)	Shows the beginning of the Help file.
Next (or PAGE DOWN)	Shows the next screenful of Help information. Typically, not all the relevant information is shown, and Next (press the letter N) should be used.
Previous (or PAGE UP)	Shows the previous screenful of Help information.
Applications	Shows a list of common problems paired with the names of the commands that offer solutions.
Commands	Shows the description of the first command (Alpha).
Editing	Shows the description of Multiplan editing.
Formulas	Shows a list of all functions and the rules about formulas.
Keyboard	Shows the keytop labels corresponding to Multiplan action keys.

Insert

Insert

INSERT: Row Column

Select option or type command letter

Presents a choice of ways to insert new cells into the worksheet.

- Insert Row inserts new rows, moving the rest down.
- Insert Column inserts new columns, moving the rest to the right.

Multiplan adjusts all references affected by the insertion. See “Transforming the Worksheet” in Chapter 8, “Elements of Multiplan,” for the description of how the Insert command affects references.

The Insert command will not be carried out if the insertion would push data off the edge of the sheet. If, for example, you have data in column 255, an attempt to insert even one column will receive the message “Not a valid option.” Similarly, if you have data in column 240 and attempt to insert 16 columns, you will receive the “Not a valid option” message.

The subcommands are explained individually below.

See Also

Move to move rows or columns on the sheet.

Delete to remove rows or columns.

Insert Column

Insert Column

```
INSERT COLUMN # of columns: 1 before column: 1
              between rows: 1 and: 4095
Enter number
```

Inserts all or part of a column or columns of blank cells. This command is most commonly used to insert complete new columns by accepting the proposed responses of rows 1 and 4095.

Parts of columns can be inserted. Insertion takes place between the specified rows; other rows are not affected.

Cells to the right of the inserted ones move right.

Examples

To add a column just left of the active one (column 3):

```
INSERT COLUMN # of columns: 1 before column: 3
              between rows: 1 and: 4095
```

To insert a rectangular area in columns 5 and 6 between rows 3 and 8, causing parts of rows 3 through 8 to move right to make room:

```
INSERT COLUMN # of columns: 2 before column: 5
              between rows: 3 and: 8
```

Insert Row

Insert Row

```
INSERT ROW # of rows: 1 before row: 1
              between columns: 1 and: 255
Enter number
```

Inserts all or part of a row or rows of blank cells. This command is most commonly used to insert complete rows above the active row by accepting the proposed responses of the active cell and columns 1 and 255.

The command can be used to insert parts of rows. Insertion takes place between the specified columns; other columns are not affected.

Cells below the ones added move down.

Examples

To insert a new row above row 7:

```
INSERT ROW # of rows: 1 before row: 7
              between columns: 1 and: 255
```

To insert a rectangular area in rows 4 and 5 between columns 1 and 8, causing the lower parts of columns 1 through 8 to move down to make room:

```
INSERT ROW # of rows: 2 before row: 4
              between columns: 1 and: 8
```

Lock

Lock

LOCK: Cells Formulas

Select option or type command letter

Provides two ways to lock cells to protect them from accidental change.

- Lock Cells locks and unlocks selected cells.
- Lock Formulas locks all cells that contain text or formulas.

The values of locked cells cannot be changed by the commands Alpha, Blank, Copy, Edit, Value, or eXternal.

Locked cells are still affected by the commands Delete, Format Cells, Insert, Move, and Sort.

When some cells are locked, the NEXT UNLOCKED CELL key positions the cell pointer on the next unlocked cell that is not blank. Similarly, the PREVIOUS UNLOCKED CELL key positions the pointer on the previous unlocked cell that is not blank.

Using the Lock command and these action keys, you can quickly locate variable quantities on a complex worksheet and perform “what if” experiments.

The subcommands are explained individually below.

Lock Cells

Lock Cells

LOCK cells: **R1C1** status: Locked(Unlocked)

Enter reference to cell or group of cells

Displays and changes the protection status of cells.

The proposed responses show the status of the active cell.

Lock or unlock selected cells by selecting the appropriate response in the “status” field.

Cells locked by eXternal Copy may not be unlocked with this command.

Examples

To lock an unlocked active cell (R1C1):

LOCK Cells: R1C1 status:(Locked)Unlocked

To unlock the whole worksheet:

LOCK Cells: R1:R4095 status: Locked(Unlocked)

Lock Formulas

Lock Formulas**LOCK FORMULAS:**

Enter Y to save edits, N to lose edits, or cancel

Entering Y locks all cells that contain text or formulas. Cells that contain numbers are not affected by the Lock Formulas command.

The Lock Formulas command protects all values generated by formulas. Numbers and any entries made after locking are the exception, and you must decide which unlocked cells you want to lock.

See Also

Lock Cells to lock cells with numbers and to unlock cells.

Move

Move

MOVE: Row Column

Select option or type command letter

Presents a choice of ways to move cells from one place to another on the sheet.

- Move Row moves whole rows.
- Move Column moves whole columns.

More complex moves can be made by inserting blank cells at the destination, copying the source cells into the destination cells, then deleting the source cells.

The destination of a move is identified by the row or column that will follow the moved cells. That row may or may not be displaced, depending on the direction of the move.

For example:

Move 1 to before 5: Move 5 to before 2:

Move 1 to before 5

Move 5 to before 2

original

moved rows

original

moved rows

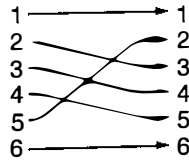
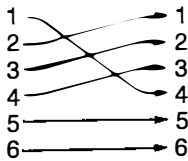

Moving cells causes the worksheet arrangement and all references to be adjusted. See “Transforming the Worksheet” in Chapter 8, “Elements of Multiplan,” for the description of how the Move command affects the worksheet.

The subcommands are explained individually on the following pages.

See Also

Copy to duplicate cells.

Delete to delete rows or columns.

Insert to add rows or columns.

Move Column

Move Column

MOVE COLUMN from column: to left of column: 1 # of columns: 1

Enter a number

Moves a group of columns to a new position on the worksheet.

Example

To move the active column (column 9) to the left edge of the sheet, moving all columns now to the left of the active column to the right one column to make room:

MOVE COLUMN from column: 9 to left of column: 1 # of columns: 1

Move Row

Move Row

MOVE ROW from row: 1 to before row: 1 # of rows: 1

Enter number

Moves a row or group of rows to a new position on the worksheet.

Example

To move the active row (row 5) to the top of the sheet, moving all rows now above the active row one row down to make room:

MOVE ROW from row: 5 to before row: 1 # of rows: 1

Name

Name

NAME: define name:
macro: Yes No
Enter name

to refer to:
command key(s):

Assigns a name to a cell or area of cells. The name may then be used to refer to that cell or area in a command or formula.

The proposed response for the “define name” field is either a blank or text. If the active cell contains text, Multiplan proposes that text, with any illegal characters removed, as the name to be defined. This makes it easy to convert a title already given to a row or column into a name.

If cell R5C1 contains the text Costs as a title, then the Name command can be used to define the name Costs as R5C2:15. Text used as titles and names are very different and should not be confused. However, it will be easier to read your formulas if the names in them correspond to the visible titles on your worksheet.

If you want the name to be something besides the proposed response, simply type the new response.

The proposed response for the “to refer to” field is either the active cell or, if the last name defined was a vector (a portion of a row or column), the same vector shifted to the active row or column. This feature makes defining parallel groups a simple task.

If the name you enter is already defined, after you press TAB the proposed response in the “to refer to” field will show the current definition.

Names must begin with a letter. The rest of the characters of a name may be any combination of letters, numbers, the period (.), and the underscore (_). (These rules are the same ones used in the BASIC programming language.) Proposed responses are automatically made to conform to these rules. Illegal characters are ignored and underscores are substituted for blanks embedded in text strings.

Names may be up to 31 characters long.

Names may not be a combination of characters that could be confused with a reference. See the descriptions of references in the “Formulas” section of Chapter 8, “Elements of Multiplan.”

To see the names that have been defined, select the Name command. Use the direction keys to display each defined name and its definition in the command fields.

To change the definition of a name after viewing it, use the edit keys to alter the response in the “to refer to” field and press RETURN.

Names are deleted by making them refer to no area. Enter the name in the “define name” field, delete the response in the “to refer to” field, and press RETURN.

The “macro” and “command keys” options are used in naming macros. Appendix A, “Macros,” contains a detailed discussion of this feature.

Example

To define row 10, columns 3 through 15 as Sales:

NAME: define name: Sales to refer to: R10C3:15

Hint To save time, define names for the common areas on your worksheet. By defining names, you speed up references to a group of cells. For example, it is much easier and faster to type *Sales* than *R2C3:15*, or *Hotspots* than *R3C4,R5C6,R5C8*. Use the REFERENCE key (@) to enter names directly from the name table.

See Also

eXternal Copy for names associated with external links.

Options

Options

```

OPTIONS recalc:  No      mute: Yes(No)
           iteration: Yes(No)    completion test at:
Select option

```

The proposed responses show the current settings.

The “recalc” option controls when Multiplan performs formula calculations. If the “recalc” option is set to “Yes,” Multiplan recalculates all formulas whenever a cell is changed. If the “recalc” option is set to “No,” recalculation is done only when the **RECALC** key (!) is pressed or during Transfer Save.

Hint To save time, turn off automatic recalculation, and use the **RECALC** key (!). This way you can enter new values and edit current values without waiting for each recalculation. Recalculation also occurs when you change text.

The length/of time Multiplan takes to recalculate a sheet depends on how many cells are in use, and on the complexity of the formulas in them. When you want to make many entries on a busy worksheet, set the “recalc” option to “No” for quicker response. Set “recalc” to “Yes” again when you want to see the effect of each change.

The “mute” option controls the Multiplan audible alarm. The initial setting is “No,” which means the alarm sounds when an error is made. Select “Yes” when you want to mute the alarm.

The “iteration” option and the accompanying “completion test” allow for the use of numerical approximation methods that involve circular dependencies. Such methods are applicable to a wide range of problems, which includes solving simultaneous equations, calculating internal rate of return, and finding roots of equations. Appendix B, “Solving Extended Problems with the Iteration Option,” contains a detailed discussion of this powerful feature.

After you press the **RETURN** key, Multiplan will display in the message line its version number and the total bytes of storage (corresponding to 100% Free) that are available to Multiplan.

Print

PRINT: Printer File Margins Options

Select option or type command letter

Presents a choice of four actions related to printing the active worksheet.

- Print Printer begins printing.
- Print File stores printable output in a disk file.
- Print Margins sets the margins for the printed output.
- Print Options specifies the part of the worksheet to be printed and controls part of the printed format and printer setup.

The subcommands are explained individually below.

Print File

PRINT on file:

Enter filename

Stores printed output in a disk file rather than sending it to the printer. Such files have several uses. The file might be printed at a later time. You might use a text editor to alter the file before printing it, or you could include the file as an illustration in another text file.

If a file of the same name exists, Multiplan will display the message “Enter Y to overwrite file.” Press Y to start printing. Pressing any other key cancels the Print File command.

Example

To write a print formatted version of a file to the name *BUDGET*:

PRINT on file: BUDGET

Print

Print File

Print Margins

Print Margins

```
PRINT MARGINS: left: 5 top: 6 print width: 70 print length: 54
                page length: 66
Enter a number
```

Alters the margins and page length for printed output. The left margin and the print width are given as a number of characters. The top margin, print length, and page length are given as a number of lines.

The “print width” field sets the maximum number of characters to be printed on each line. The “print length” field sets the maximum number of lines of print on each page. The “page length” field sets the length of the paper so that a form feed advances the paper the correct number of lines to begin printing on the next page.

The proposed responses are those created by the last Print Margins command. In addition, margins are saved with the sheet.

When the Print Margins command is complete, the Print command is displayed again.

Example

A sheet of letter-size paper is 8.5" x 11". Assuming the printer prints 10 characters per inch across a page and 6 lines per inch down a page, the page length is 66 lines and the page width is 85 characters. To fill these dimensions, you might want a top margin of 3 and a print length of 60 for a bottom margin of 3. A print width of 65 characters leaves 20 characters total for the right and left margins. To center lines on the page, you need a left margin of 10.

```
PRINT MARGINS: left: 10 top: 3 print width: 65 print length: 60
                page length: 66
```

Print Options

Print Options

```
PRINT OPTIONS: area:          setup:
                formulas: Yes(No) row-col numbers: Yes(No)
Enter reference to cell or group of cells
```

Sets four optional features before printing:

- printing only part of the sheet,
- printing formulas rather than their values,
- suppressing row and column numbers from the printed page,
- some set-up of printer hardware.

If you want to print only part of the worksheet, specify a reference to a rectangular group of cells, in the “area” field.

Depending on your hardware configuration, the “setup” field may be used to set up the printer hardware (see the section entitled “Operating Information”).

If you choose to print “formulas,” the listing will display the actual formulas that appear in each cell, rather than the calculated values of the formulas, as it normally would. This feature is useful when you want a record of the logic behind a worksheet. Column widths are doubled when “formulas” is set to “Yes.”

If you select Yes for the “row-col numbers” field, row and column numbers will be printed.

Example

To print only an area named “Factors,” which holds discount percentages:

```
PRINT OPTIONS: area: Factors      setup:
                formulas: Yes(No)  row-col numbers: Yes(No)
```

Print Printer

Print Printer

PRINT on printer:

Starts printing the sheet under the conditions set up by the Print Margins and Print Options commands.

The time it takes to print depends on the size of the sheet and the speed of the printer.

Empty columns at the right of, and empty rows at the bottom of the sheet are not printed. Multiplan prints as many columns across the page as will fit in the print margins. If there are rows left over, it prints a second page, repeating the same columns. When all the rows have been displayed, Multiplan starts the next set of columns on a new page. Thus, if the area to be printed is wider than the paper, you can assemble the complete width by cutting and pasting later.

Press CANCEL to interrupt printing.

If a printer error occurs during printing, Multiplan will display the "Printer error" message.

See Also

Print File to direct output to a disk file.

Print Margins to set the dimensions of a page.

Print Options to print part of a sheet, to print formulas, or to print row and column numbers.

Quit

Quit

QUIT:

Enter Y to save edits, N to lose edits, or cancel

Ends the Multiplan session. When you press the letter Q, Multiplan displays the message "Enter Y to confirm." Press Y to quit, or any other letter to resume.

If you have made changes to your worksheet since the last time you saved it, Multiplan will display the message "Enter Y to save edits, N to lose edits, or cancel."

If you press Y, Multiplan saves your work and returns you to the DOS prompt. If you press N, Multiplan quits without saving your work. Press any other key to cancel the command.

Every time you quit, Multiplan automatically saves certain setup information in a file called MP.INI. Multiplan saves the conditions you have set in the following fields:

- Options Recalc and Mute
- Transfer Options Setup
- Print Margins
- Print Options Setup

The next time you load Multiplan, these fields will reflect whatever settings each field held the last time you quit.

See Also

Transfer Save to save the active sheet.

Sort

SORT by column: **1** between rows: 1 and: 4095 order: (>)<
Enter number

Reorders the rows on the worksheet within the specified column so that the values will be sorted.

The proposed response for the column field is the active column. The proposed response for the rows is the whole column. The proposed sorting order is ascending order, from least to greatest.

The column to be sorted may contain numbers, text, or other values. Sorting collects the different types into the following groups:

- 1st Numbers
- 2nd Text
- 3rd Logical and error values
- 4th Blank cells

Numbers and text are further sorted into either ascending (>) or descending (<) order. Text is arranged according to the ASCII standard character sequence, that is, from “least” to “greatest”:

```
!"#$%&'()*+,-./0-9:;  
<=>?@A-Z[ ]^_`a-z{|}~
```

Within each type, equal values are left in the order Multiplan encounters them.

The worksheet can be sorted on multiple columns. To do this, sort the least significant column first. Then, sort the other columns one at a time, from the least significant to the most significant. The example below illustrates this method.

References on the worksheet are adjusted as described in the “Transforming the Worksheet” section of Chapter 8, “Elements of Multiplan.”

Sort

To generate a sorted report without the effects of the adjusted formulas, turn off automatic recalculation. Multiplan then displays the values calculated before the sort was performed. You can print this sorted sheet, but do not save it.

Note also that numbers intermixed with text in a cell or dates represented as text are sorted by the rules of standard alphabetization. For example, "A10" is sorted as *less than* "A9."

Example

To sort a list of checks into categories (in column 1) by amount (in column 2) with the largest amount at the top of each category, first sort all checks by amount in descending order:

```
SORT by column: 2 between rows: 1 and: 4095 order: ) (<)
```

The checks are listed from largest to smallest, but with the categories unsorted. To sort the categories alphabetically:

```
SORT by column: 1 between rows: 1 and: 4095 order:( ) (<)
```

The checks are now sorted into categories. The checks within each category are arranged from largest to smallest. Because Multiplan leaves equal items in the order it finds them in the column it is sorting, any previous sorting in other columns is retained.

Transfer

Transfer

TRANSFER: Load Save Clear Delete Options Rename

Select option or type command letter

Offers a choice of six subcommands which affect an entire sheet.

- Transfer Load loads a saved sheet, replacing the active sheet.
- Transfer Save saves the active sheet in a disk file.
- Transfer Clear clears the active sheet, deleting all its contents.
- Transfer Delete deletes a file on the diskette.
- Transfer Options specifies which disk drive to use, or which file format.
- Transfer Rename saves the active sheet under a new name and updates external links.

The subcommands are explained individually below.

Transfer Clear

Transfer Clear

TRANSFER CLEAR:

Enter Y to save edits, N to lose edits, or cancel

Clears the active sheet after you type Y to confirm the command. Typing any other key cancels the command.

Using the Transfer Clear command is almost the same as starting up Multiplan; that is, all cells are deleted; all columns are set to the default width; the default alignment and format are set to General; all names and all links to external sheets are cleared; and the sheet name is set to TEMP. The exceptions are that options set with the Options, Format Options, Transfer Options, and Print Options commands are preserved.

If a copy of the active sheet has previously been saved with Transfer Save, that copy is not affected.

See Also

Blank to replace the contents of specified cells with blanks.

Delete to delete specified cells.

Transfer Save to save the active sheet as a disk file.

Transfer Delete

Transfer Delete

TRANSFER DELETE filename:

Enter filename or use direction keys to select from list

Deletes a saved worksheet from a diskette.

Pressing one of the direction keys causes Multiplan to display a directory of files on the diskette. To use the direction keys, see the directory display explanation under the Transfer Load command. Press the RETURN key to select the filename that is highlighted.

When you press the RETURN key, Multiplan displays the message "Enter Y to confirm." Press Y to delete the file. Pressing any other key cancels the Transfer Delete command.

Use Transfer Delete to clear your diskette of unwanted files.

Transfer Load

Transfer Load

TRANSFER LOAD filename:

Enter filename or use direction keys to select from list

Loads a sheet from a disk file. The disk file's name must be spelled and punctuated exactly as it was when the sheet was saved with the Transfer Save command.

Pressing any one of the direction keys causes Multiplan to display a directory of files on the diskette. The direction keys may be used whether the "filename" field is empty or has a filename filled in.

When the "filename" field is empty, the entire first page of the directory is displayed. If you need to see more, use the PAGE DOWN and PAGE UP keys to scroll full screens of the directory.

When you enter a filename in the "filename" field then press a direction key, Multiplan uses the filename you enter as a pattern and displays only those filenames on the default diskette that match the pattern.

Once the directory is on the screen, use the direction keys to move the highlight among the filenames. As you do, the highlighted filename also appears as a proposed response in the "filename" field in the command line. Press the RETURN key to load the highlighted file.

While the directory is visible, pressing any other key besides a direction key causes the worksheet previously on the screen to reappear. This other key has the same effect as it does while editing responses in command fields that need to be filled in, as described in the "Editing" section of Chapter 8, "Elements of Multiplan."

When you load a "Normal" or Lotus file (see Chapter 8, "Using Worksheets from Other Programs"), it replaces the sheet on display and becomes the active sheet. If you load one of these worksheets while another worksheet is on your screen, you will get the message: "Press Y to save edits, N to lose edits, or cancel."

- Press Y to save the active worksheet and then load the new file.
- Press N to erase the active worksheet and load your file.
- Press Esc to cancel the command.

If you chose Transfer Options Other to load a Visicalc file (see Chapter 8, “Using Worksheets from Other Programs”), or you are loading a CONVERTD file (Appendix C), you may want to start with a blank worksheet. Otherwise, these files would merge with the active worksheet.

Example

To load a sheet saved in a file named INCOME:

```
TRANSFER LOAD filename: INCOME
```

See Also

Transfer Save to save the active sheet as a disk file.

Transfer Options

Transfer Options

```
TRANSFER OPTIONS mode:      Symbolic Other      setup:
```

Select option

The “mode” field specifies the file format for all subsequent Transfer Load and Transfer Save commands.

The format choices are:

Normal: Multiplan binary format. External references require that the referenced worksheet be saved in Normal format. This format is also the most efficient use of disk space and requires the least transfer time.

Hint Use the Normal mode for saving and loading files, whenever possible. If you load a file that is in Symbolic or Other mode, save it in Normal mode when you are finished with it. Files in Normal mode load much faster than files in the other modes.

- Symbolic:** The format for data interchange with other programs.
- Other:** Lotus 1-2-3, Lotus Symphony, or Visicalc file format for loading files. See Chapter 8, "Using Worksheets from Other Programs," for information on loading any of these files.
When you save a worksheet with the Other option, Multiplan saves it in the 1-2-3 format. See Chapter 8, "Using Worksheets from Other Programs," for information on saving a file in the 1-2-3 format.

The "setup" field changes the default disk drive from the drive currently being used to the drive specified for all subsequent Transfer commands.

The proposed responses show the current settings.

Example

Multiplan was started on drive B:. To simplify use of a data diskette in drive A:

```
TRANSFER OPTIONS mode:(Normal)Symbolic Other   setup: A:
```

Transfer Rename

Transfer Rename

```
TRANSFER RENAME filename: (name of active sheet)
```

```
Enter filename
```

Saves the active sheet in Normal mode under a new name and adjusts external links to supporting and dependent sheets. Deletes the file with the previous sheet name. (See the "Files" section of Chapter 8, "Elements of Multiplan," for a description of external links.)

If the sheet was previously saved in a mode other than Normal mode, using the Transfer Rename command results in the error message "Not a valid option."

Example

To rename the active sheet JUNE82:

```
TRANSFER RENAME filename: JUNE82
```

See Also

Transfer Load to load a saved sheet.

Transfer Save to save the active sheet as a disk file.

Transfer Save

Transfer Save

TRANSFER SAVE filename: (name of active sheet)

Enter filename

Saves the active sheet as a disk file, which can later be loaded with *Transfer Load*. The proposed name for the disk file is the name last given with *Transfer Save* or *Transfer Rename*, or the name last loaded with *Transfer Load*, or TEMP if the sheet is clear or was not previously named.

If the filename is a duplicate of one that exists on the diskette already, the message “Enter Y to overwrite file” appears when you press RETURN. Press Y to replace the file on diskette with the worksheet on the screen. Pressing any other key cancels the *Transfer Save* command.

If you want to rename the sheet, we recommend using the *Transfer Rename* command if you have any external links to supporting sheets. *Transfer Save* will not update the “receipts” on the supporting sheets if you rename the active sheet using the *Transfer Save* command. Refer to “Files” in Chapter 8, “Elements of Multiplan,” for a discussion of external links and “receipts.”

You can save your Multiplan files in Normal, Symbolic, or Other (Lotus 1-2-3) mode. Before you save your file in Other mode, make sure it has the 1-2-3 “.wks” extension. For example, you would type *practice.wks* in the “filename” field for a file named “practice.”

Examples

To save the active sheet under the proposed name, simply press RETURN.

To save the active worksheet under the name PRACTICE:

TRANSFER SAVE filename: PRACTICE

See Also

Print File to put the displayed form of the sheet in a disk file.

Transfer Load to load a sheet saved previously.

Transfer Options to set the mode.

Transfer Rename to save the worksheet under a new name and to update “receipts.”

Value

Value

VALUE:

Enter formula

Used to enter a formula or a number into the active cell.

Besides selecting Value from the command menu by highlighting Value and pressing RETURN or by typing V, the Value command can be selected by:

- 1 typing any digit, 0-9
- 2 typing one of the characters =, +, -, ., ", and (. Except for the equal sign (=), these characters are also entered as the first character of the formula.

Inside formulas the direction keys enter relative references into the formula. See the “Editing” section of Chapter 8, “Elements of Multiplan,” for more information about editing responses to a command.

Terminate the Value command by:

- 1 pressing RETURN
- or
- 2 pressing an action key that moves the cell pointer, such as a direction key, to the end of a number or complete formula. The formula or number is stored in the active cell, and the cell pointer is moved as directed.

Multiplan then displays:

ALPHA/VALUE:

and awaits the entry of text or another value. This feature is described in detail under the Alpha command.

Text may be entered if enclosed in double quotation marks.

Example

The simple method of entering a list of numbers, using a direction key:

31 *RIGHT* 28 *RIGHT* 31 *RIGHT* 30 *RIGHT* 31 *RIGHT*

is a series of Value commands.

Note that dates of the form 1/27/84 can be interpreted as formulas. Be sure to enter dates as text, using the Alpha command, or enclose them in double quotation marks.

See Also

Alpha for entering text and titles or a sequence of text and values.

Edit for editing formulas.

Window

WINDOW: Split Border Close Link Paint

Select option or type command letter

Presents a choice of window operations.

- Window Split opens a new window by splitting the active window horizontally or vertically, or opens a window used for titles.
- Window Border adds or removes a border around a window.
- Window Close closes a window by removing it from the screen.
- Window Link links two windows so that their contents scroll together.
- Window Paint selects colors for the display of the active window and other windows on the screen.

The NEXT WINDOW key moves the cell pointer from one window to the next. The PREVIOUS WINDOW key moves the pointer back to the preceding window.

Window

The subcommands are explained individually below.

Window Border

Window Border

WINDOW change border in window number:

Enter number

Changes the border of the specified window. If the window presently has a border, it is removed. If it lacks a border, one is added.

A border takes up one screen position on each side of the window, reducing the area for the display of data by two screen lines and two screen columns.

Window Close

Window Close

WINDOW CLOSE window number:

Enter number

Removes the specified window from the screen. The active window is the proposed response.

The size of the remaining windows is increased to occupy the screen area used by the closed window. Windows are renumbered. Cell contents are not affected by closing a window.

If there is only one window open, the Window Close command is ignored.

See Also

Window Split to open windows.

Window Link

Window Link

WINDOW LINK window number: 0 with window number: 0 linked: Yes(No)

Enter number

Reviews and revises the links between two windows. The links may have been established under the Window Split command, or they may not exist yet, in which case you may establish links between windows split from a common window so that the two windows scroll together.

The proposed responses specify the active window and either a window split from the active window or the window from which the active window was split. If no window splitting has occurred, both proposed window responses will be the active window.

You may enter any two window numbers as responses. But only those pairs that share the split relationship can be linked. Attempts to link other pairs receive the message "Cannot link those windows" in the message line.

When windows are linked, the contents of the two windows scroll together. If the window split was horizontal, the synchronized scrolling is horizontal. If the window split was vertical, the synchronized scrolling is vertical.

When two previously unlinked windows are linked, one set of row or column numbers disappears from the screen. If the pairs are related by a horizontal split, the column numbers disappear. Columns are identified by the numbers in the window above.

If the pairs are related by a vertical split, the row numbers disappear. Rows are identified by the numbers in the window to the left.

This command is also used to unlink windows, but you cannot unlink windows split by the Window Split Titles command.

Example

Window #4 was split from window #1. To link them so that they scroll together:

WINDOW LINK window number: 4 with window number: 1 linked:(Yes)No

See Also

Window Split for a description of window links.

Window Paint**Window Paint**

WINDOW PAINT foreground: background: border:

Enter number or use direction keys to select color

Selects the colors for the display of the active worksheet. You can choose separate colors for the foreground, background, and border. The Window Paint values are saved when you save the worksheet with the Transfer Save command.

Color is available only for the IBM PC, IBM PC-XT, IBM PC-AT, IBM PC Jr, and other systems that are strictly compatible.

Use the NEXT WINDOW key to select the window you wish to color.

Choose colors by typing the color code number or by using the direction keys to view and select from the colors available. The direction keys select colors as follows:

- RIGHT Selects the next higher color number.
- LEFT Selects the next lower color number.
- DOWN Selects the highest color number (15).
- UP Selects the lowest color number (0).

When you press a direction key, the selected color is displayed so you can preview the available colors for each part of the worksheet. Press RETURN to accept the selected colors. Press CANCEL to return the worksheet to the original colors.

The cell pointer is ordinarily light gray, and the characters within the highlight are black. If the background color is light gray, the cell pointer will be black and the characters will be light gray.

The color codes are as follows:

- | | | | |
|---|------------|----|---------------|
| 0 | Black | 8 | Dark Gray |
| 1 | Blue | 9 | Light Blue |
| 2 | Green | 10 | Light Green |
| 3 | Cyan | 11 | Light Cyan |
| 4 | Red | 12 | Light Red |
| 5 | Magenta | 13 | Light Magenta |
| 6 | Yellow | 14 | Light Yellow |
| 7 | Light Gray | 15 | White |

Not all color monitors can display colors 8 through 15.

If you create and paint a worksheet on an 80-column color monitor and later display the worksheet on a different type of monitor, the worksheet may not appear with the colors you set.

Color and intensity may vary depending on your display device. Typically, the colors 8 through 15 appear as “light” or “high-intensity” values of the colors 0 through 7.

On an IBM monochrome or similar black-and-white display, colors appear as different shades. Also, certain settings can be used to produce these special results:

- Setting *foreground* to 0 or 8 and *background* to 7 or 15 displays dark characters on a light background.
- Setting *foreground* to 1 or 9 underscores across the rows.
- Setting *border* to 1 or 9 marks rows on the window border (of different brightness).
- Setting *border* to 0 or 8 and setting *background* to 7 displays a light hand along the window border.

On a monitor that displays color in 40-column mode only, the worksheet appears in black and white in 80-column mode. If your worksheet doesn't appear, set the window colors to:

Foreground:7
Background:0
Border:7

To make the worksheet contents black on a white background, use the following settings:

Foreground:0
Background:7
Border:0

However, if any of the windows created in 80-column mode cannot be displayed in 40-column mode and you save and then display the worksheet in 40-column mode, windows 2 through 8 close automatically. In this case, only the colors of window 1 appear on the screen.

Because the IBM color/graphics monitor adapter does not support gray shades, the results may be unpredictable if you use colors other than 0, 7, 8, or 15 on a black-and-white monitor attached with this adapter.

Window Split

Window Split

WINDOW SPLIT: Horizontal Vertical Titles

Select option or type command letter

Presents a choice of three ways to open a window by splitting the active window.

- Window Split Horizontal splits the active window across the screen, giving two windows, one above the other.
- Window Split Vertical splits the active window between columns.
- Window Split Titles splits the screen both vertically and horizontally to display titles in separate windows.

Up to eight windows may be opened using the Window Split commands.

The Window Split commands retain window borders, giving both windows a border if the original window has one.

See Also

Window Close to close a window.

Window Link to link and unlink existing windows.

Window Split Horizontal

Window Split Horizontal

WINDOW SPLIT HORIZONTAL at row: linked: Yes(No)

Enter number

The active window is split horizontally. The display space used by the given row and the rows below it becomes the new window. The space above the given row remains part of the original window.

The new window is given the next unused window number and is made the active window.

The original window and the new window may be linked. If you select “Yes” in the “linked” field, whenever you scroll one of the windows horizontally, both windows scroll together. Notice also that the column numbers of the lower window do not appear on the screen. Rather, the column numbers of the window above are used to identify columns in the linked window.

Examples

To split the active window at the active row, just press RETURN.

To split the active window at the display line presently showing row 34, and to link the windows:

```
WINDOW SPLIT HORIZONTAL at row: 34  linked:(Yes)Mo
```

See Also

Window Link to review or revise links between windows.

Window Split Titles

Window Split Titles

```
WINDOW SPLIT TITLES: # of rows:      # of columns:
```

```
Enter number
```

The active window is split to form two or four windows. The windows formed are linked so that they scroll together. Windows linked by this command cannot be unlinked.

The specified number of rows becomes a window at the top of the display space occupied by the original window, unless the number is 0.

The specified number of columns becomes a window at the left of the display space occupied by the original window, unless the number is 0.

The remaining display space becomes the active window. It is linked for horizontal movement with the window above it, and for vertical movement with the window to its left, if any.

The proposed responses split the window so that the active cell becomes the upper left corner cell of the active window.

Example

Suppose that column 1 contains descriptive titles for the rows of the worksheet, and that columns 2 through 25 contain data matching those titles. You would like to scroll the data columns horizontally while holding the titles fixed on the screen. If you scroll vertically, both titles and data should move so that the titles will remain aligned with the matching data. Move the cell pointer to R1 C2, then the proposed response will be:

```
WINDOW SPLIT TITLES: # of rows: 0   # of columns: 1
```

See Also

Window Border to draw a border around any of the windows.

Window Split Vertical

Window Split Vertical

```
WINDOW SPLIT VERTICAL at column:      linked: Yes(No)
Enter number
```

The active window is split vertically. The display space used for the given column and the columns to its right is used for the new window. The space used for columns to the left of the active column remains part of the original window.

The new window is given the next unused window number and becomes the active window.

The original window and the new window may be linked. If you select "Yes" in the "linked" field, whenever you scroll one of the windows vertically, both windows scroll together. Notice also that the row numbers of the right window do not appear on the screen. Rather, the row numbers of the window to the left are used to identify rows in the linked window.

Examples

To split the window at the active column, just press RETURN.

To split the window at the column presently displaying column 3:

```
WINDOW SPLIT VERTICAL at column: 3   Linked: (Yes)No
```

See Also

Window Link to review or revise links between windows.

eXternal

eXternal

EXTERNAL: Copy List Total Use

Select option or type command letter

Presents a choice of actions relating to the use of data on inactive (external) sheets.

- eXternal Copy copies data from an inactive worksheet to the active worksheet. This command can also establish an external link, a permanent relationship that automatically causes data to be copied from a source, or supporting sheet, to the active, or dependent, sheet every time the latter is loaded into Multiplan.
- eXternal List displays the lists of supporting and dependent worksheets.
- eXternal Total combines the named worksheet with the current worksheet on a cell-by-cell basis.
- eXternal Use assigns a substitute name for a specified sheet.

Hint Use the eXternal commands to split sheets at logical places. The method of splitting up your work should follow the natural breaks in your tasks. By splitting up your task into smaller tasks, you can keep your worksheets smaller and faster to work with.

See the “Files” section in Chapter 8, “Elements of Multiplan,” for more information on external links and file accesses.

The subcommands are explained individually below.

eXternal Copy**eXternal Copy**

```
EXTERNAL COPY from sheet:          name:
                             to: R C    linked:(Yes)No
Enter name on external sheet
```

Copies values from a group of cells on an external worksheet to the active sheet. The source sheet is defined in the “from sheet” field of the command. The proposed response for the “from sheet” field is the most recent new supporting sheet.

The cells to be copied from the source sheet are described in the “name” field. This field may contain a name which is defined on the source sheet to refer to a group of cells, or it may be an absolute reference to a single rectangle on that sheet (e.g., R2C1:12; see also the discussion of absolute references in the “Formulas” section of Chapter 8, “Elements of Multiplan”).

The “to” field is used to specify the destination of the copy on the active sheet. The proposed response is the active cell. If a single cell is specified in this field, the source group will be copied starting at that cell. If a group of cells is specified in the “to” field, the shape of the group must correspond to the shape of the source group, cell by cell. Otherwise, an error message is displayed, and the copy does not take place.

The integrity of the active sheet is further protected by checking that all destination cells are blank. An attempt to copy into a non-blank cell also causes an error message, and copying is canceled.

The eXternal Copy command does not copy formulas, but only the values derived from formulas. This is different from the “Copy” group of commands because those commands copy formulas as well as values. For example, if a cell containing the formula $100*rate$ is copied from an external sheet, the destination cell may receive the constant value 20 (assuming $rate = .20$). This value alone does not show the dependence of the result on changes to the *rate* cell on an external sheet. The external link facility is provided to express permanently the relationship between the value on the “dependent” sheet and the source of the value (the formula on the “supporting” sheet).

External links are controlled by the options in the “link” field of the eXternal Copy command. If “No” link is selected, the command has no other effect than copying the values as described above. Information on possible dependencies is not recorded at all. If the source data is not expected to change, this option would be the most convenient.

Selecting “Yes” in the “link” field establishes an external link between the source data and the destination. The source sheet supports the active, or dependent, sheet. Of course, the same sheet may be in supporting and dependent roles in different external links.

After an external link is established, every time the dependent sheet is loaded (using the Transfer Load command), all the data described in the external links is automatically copied from the source sheets to the specified destinations. Any change in the source data is reflected on the dependent sheet.

The “formulas” associated with the destination cells—as seen on the status line or using the “formulas” Format Option—also show the data in the cells as dependent on a link, in the form:

[sheetname sourcename]

Destination cells are protected from changes just as if they were locked. They can be “unlocked” only by removing or redefining the external link in which the cells participate.

To remove a link, specify the source sheet, source name, empty destination, and “Yes” for linking in the eXternal Copy command.

To redefine a link so that it has a different destination on the active sheet, redefine the link with a new destination on the active sheet. Because a source area on an inactive sheet may be copied only once by each active sheet, the new destination replaces the former one in the link.

Both the removing and redefining of links, as well as the review of the existing links, is simplified by the use of the direction keys to step through the source (supporting) sheet names or the names of source cells in a given sheet. The “to” field is filled in by Multiplan to show the destination of the external link, as currently defined.

The Name command, when used immediately after an eXternal Copy, proposes to define the name

sheetname.sourcename

to refer to the destination of the copy. When defined (by pressing RETURN), this name can be used in other formulas on the active sheet to refer to the copied data.

The automatic copying process from supporting sheets requires that the files that contain the sheets be available to Multiplan.

This topic is discussed in the “Files” section in Chapter 8, “Elements of Multiplan.”

Before copying the data in each link, the definition of the name for the source cells is checked. If the shape (size) of the named area has been changed, an error message is displayed, and the copy does not take place. Otherwise, the cells are copied to the destination cells, even if the destination cells are not blank but contain the results of the previous external copy.

Example

To copy the value of the area named *Sales* from the worksheet named *INCOME* to the area starting at cell R5C5 on the active worksheet, and to set a permanent link:

```
EXTERNAL COPY from sheet: INCOME      name: Sales
                  to: R5C5              linked:(Yes)No
```

Assuming that the area named *Sales* is a twelve-cell wide part of a row, the destination for the copy will be R5C5:16. The Name command will propose:

```
NAME define name: INCOME.Sales      to refer to R5C5:16
```

eXternal List

eXternal List

EXTERNAL LIST:

Produces a display of the names of worksheets supporting the active sheet and those dependent on the active sheet.

If the list fills more than one screen, use the PAGE UP or PAGE DOWN keys to view preceding or following screens.

The “supporting” and “dependent” relationships are explained in detail under eXternal Copy and in the “Files” section in Chapter 8, “Elements of Multiplan.”

The list of supporting sheets includes the “alias” names defined by eXternal Use.

Example

```
Sheets supporting Department;
Year81      instead of Year
Labor
```

Sheets depending on Department:
Consolidated

eXternal Total

eXternal Total

EXTERNAL TOTAL from sheet:
starting at:

name:

operation: + - * /

Multiplan combines the external worksheet or partial worksheet named in the “sheet” and “name” fields with the worksheet currently on your screen. The most common use will be to consolidate templates or models that have been filled out for different regions, departments, or time periods. You can consolidate any number of sheets with the current sheet.

You identify the worksheet to be combined in the “sheet” field. Press any direction key to display a list of worksheets.

You identify the area of the worksheet that you want combined in the “name” field. The proposed response is the whole sheet, R1C1:R4095C255. The named area can be an absolute reference or a named area of any size. Names, like sheets, can be enumerated with the direction keys.

“Starting at” designates the upper left-hand cell in the current sheet that will be matched with the upper left-hand cell of the incoming range you specified in the “name” field. The proposed response is the current selection.

You specify what you want done with the incoming sheet in the “operation” field. “Add” will add the incoming cells to the current sheet. “Subtract” will subtract the incoming cells from the current sheet. “Multiply” and “Divide” will multiply or divide the incoming cells in the same manner.

Both the incoming sheet and the current sheet must have been either created or saved with Multiplan version 2.0. See “Operating Information” in the front of this manual for more information on files.

The incoming sheet should fit within the limits of the current sheet. Any incoming cells that fall outside the borders of the current sheet (row 4095 and/or column 255) will be ignored.

The incoming sheet is combined with the current sheet on a cell-by-cell basis. The table below shows the rules that Multiplan follows when combining cells.

Cell contents are imported only as either text (anything that has been entered as an Alpha) or a value. When an incoming cell contains a formula, Multiplan takes the *result* of that formula and imports it as a value. If the incoming cell contains the result of a conditional operation, TRUE or FALSE for instance, that result is imported as text. When an incoming value encounters a blank cell, the blank cell is assumed to have a value of zero.

Contents of incoming cell	Contents of current cell	Result of eXternal Total
Text	Value Formula Text	Incoming data is ignored.
Text	Blank cell	Text inserted into cell.
Value	Text Formula	Incoming data is ignored.
Value	Value Blank cell	Incoming value is added to or subtracted from value of current cell.

In any case where incoming data is ignored, an error message will be displayed in the message line:

```
Incoming data mismatched in
```

If several items of incoming data are mismatched during the eXternal Total operation, the position of only the last mismatched cell will remain in the message line.

Example

To add a worksheet named *areal* to the worksheet currently on your screen:

```
EXTERNAL TOTAL from sheet: areal      name: RIC1:R4095C255
      starting at: RIC1                operation: + - * /
```

Combining Several Sheets at Once To combine several incoming sheets with the current sheet, you can name the incoming sheets in the "sheet" field. Separate each sheet with a comma: tempsheet,spencer,spencost.

Space in the “sheet” field is limited, so you may want to rename the sheets to be combined, adding a numeral or letter to each consecutive sheet name, for example: spencer1, spencer2, spencer3. Then you can specify a range in the “sheet” field and use a colon to divide it; for example: spencer1:spencer3. This would combine all three sheets. Letters can be added the same way, so that spencer1:spencer4 would combine spencer1, spencer2, spencer3, and spencer4.

Note, however, that eXternal Total uses only the last character in the sheetname as a guide to combining sheets. If you add extensions to your sheets that end with the same character, such as spencer1.mp, spencer2.mp, etc., the p would become the relevant character and the sheets could not be combined by specifying a range. Be sure the last character of the name is the one you want to be incremented.

eXternal Use

EXTERNAL USE filename: instead of:

Enter filename

Sets a substitute name (alias) for a sheet.

The proposed response in the second field is the previous response, if any; otherwise, it is blank.

All references to the name in the “instead of” field will be directed to the name in the “filename” field. Copies from the affected file, if any, will be redone.

The name in the “instead of” field need not be the name of an actual file. However, it must not be a substitute name. The example shows how the substitution is used.

Example

Assume that an active sheet has links to the supporting file BUDGET82. To view the figures that result from using the data on BUDGET83 instead (which must be identical in format to BUDGET82):

EXTERNAL USE filename: BUDGET83 instead of: BUDGET82

eXternal Use

This saves removing the links from BUDGET82 then redefining links to BUDGET83. Also, you can return to BUDGET82 easily by specifying BUDGET82 in both fields of this command.

As an alternative, you could use a “logical name” when referring to supporting sheets. (A “logical name” is not the name of an actual file, but a name used only for setting up external links.) Under this method, a substitution must be made through the eXternal Use command before setting up links between sheets:

```
EXTERNAL USE filename: BUDGET82          instead of: BUDGET
```

Then, the name BUDGET, which is not a file but a “logical name” used for defining links, may be used to set up the links in the eXternal Copy command and as a response in the “instead of” field in the eXternal Use command in future substitutions. For example, when you want to see the results of your budget for 1983:

```
EXTERNAL USE filename: BUDGET83          instead of: BUDGET
```

All links will now be changed to refer to BUDGET83.

This method permits you to refer to whatever file you choose in the eXternal Use command without having to remember which file is the pattern for the substitutions.

10 Functions

This chapter describes the functions that can be used in Multiplan formulas. Each entry describes the operation of a function and any special requirements for its argument.

Use one of the methods described under the Value command in Chapter 9, "Commands," to enter a formula. The functions are entered as part of a formula.

The argument to a function, enclosed in parentheses, follows the function name. No space is permitted between the function name and the left parenthesis.

Entries within the parentheses describe the argument to the function. The following abbreviations are used in argument descriptions:

- *N* represents a number; a formula that yields a number.
- Wherever *N* is shown, only one entry is allowed. When more than one is allowed, *List* is shown.
- *T* represents text; a formula that yields text.
- *Logical* represents a logical value, which must be a reference to a single cell, a formula expressing a relation (=, <, >, <=, >=, < >), or a function that returns a logical value. Otherwise, a #VALUE! error value is returned.
- *List* represents a list of items, separated by commas. An "item" may be either a value that represents itself or a reference to a group of cells that represent the collection of values in those cells. For example, the list *1,B* where "B" is defined as R1C2:3 and R1C2 contains the value 2 and R1C3 contains the value 3. The list then represents the collection of values 1,2,3. Lists may be up to five items long, but they may represent any number of values through references.

See the "Formulas" section in Chapter 8, "Elements of Multiplan," to review the descriptions of numbers, formulas, and text.

Related functions are listed under the heading “See Also.”

Hint To save effort, place common subexpressions in an intermediate cell, then refer to that cell when the subexpression is needed in a formula in another cell. This saves retyping and recomputing the same information. For example, if SUM(Sales) appears in several formulas:

```
MIN(1000,SUM(Sales))  
SUM(Sales)*commission%  
Average(Sales)
```

It is more efficient to compute SUM(Sales) once in a cell, then refer to that cell from the formulas. Having the intermediate result visible also helps with tracing problems in the setup of the formulas.

Also, to save memory, avoid functions or operations over unnecessarily large ranges. For example, instead of SUM(R2), specify only the range of columns that contain values, for instance, SUM(R2C1:5). Or, try to restructure the function or operation so that large ranges are not necessary.

ABS(N)

ABS(N)

Description

Returns the absolute value of the argument *N*.

Examples

"Difference:"&DOLLAR(ABS(first-second))

ABS(AVERAGE(R1C1:10)-R1C1)

Yields how far the first item is from the average.

See Also

SIGN for the sign of a number; ABS is equivalent to number*SIGN(number).

MAX for the maximum of two or more values.

MIN for the minimum of two or more values.

AND(List)

AND(List)**Description**

Returns the logical value true if all of the specified argument values are true. Otherwise, returns false.

Requirements

The argument entries must be logical values. If not, the #VALUE ! error value is returned.

Example

```
IF((AND(SUM(Homework)>82,Final>50)),credit,"not qualified")
```

See Also

OR and *NOT* to operate on logical values.

IF to test a logical value.

ATAN(N)

ATAN(N)

Description

Calculates the Arctangent (inverse Tangent) function of the argument, yielding an angle in radians in the range $(-\pi/2$ to $+\pi/2)$.

ATAN can be used to calculate Arcsin and Arccos.

Example

ATAN(theta row C)

See Also

TAN for the Tangent function.

AVERAGE(List)

AVERAGE(List)**Description**

Calculates the average of the specified argument values. Yields the same result as entering the formula `SUM(list)/COUNT(list)`.

Examples

`AVERAGE(Balance)`

`AVERAGE(1,5,6.5,5)`

See Also

STDEV for the standard deviation of the number values.

SUM for the sum of number values.

COUNT for a count of number values.

COLUMN()

Column()**Description**

Returns the number of the column in which the formula containing this function appears.

Example

1981+COLUMN()-4

can produce the sequence of years 1981, 1982,..., starting in column 4. (Place this formula in column 4, then Copy Right from column 4 as many cells as the number of years you want in the series.)

COS(N)**COS(N)****Description**

Calculates the Cosine of the argument, an angle in radians.

Example

`COS(theta C)`

See Also

SIN and *TAN* for the other trigonometric functions.

COUNT(List)

Count(List)**Description**

Returns the count of number values represented by the *List*. Cells are counted only if they contain number values.

Example

`DOLLAR(COUNT(checks)*0.15+1.00)&"is service charge"`

See Also

AVERAGE for the average value.

SUM for the sum of the number values.

Description

Converts the argument to text showing a dollar amount, just like the “\$” format code under the Format Cells command in Chapter 9, “Commands.”

The argument is rounded to two decimal places. If the argument is less than 1, a zero appears in the units position. A dollar sign is added before the leftmost digit. If the argument is less than zero, the result is enclosed in parentheses (the standard way of showing a negative balance in bookkeeping).

Examples

<code>DOLLAR(2.715)</code>	produces	\$2.72
<code>DOLLAR(.15)</code>	produces	\$0.15
<code>DOLLAR(0)</code>	produces	\$0.00
<code>DOLLAR(-1)</code>	produces	(\$1.00)

See Also

FIXED to format a number without the dollar sign.

VALUE to change text back to a number.

EXP(N)

EXP(N)**Description**

Calculates e (2.7182818..., the base of the natural logarithm) to the power of the argument. This is the inverse function of LN.

Powers of other bases are calculated using the exponentiation operator (^).

Examples

```
"e" is "&FIXED(EXP(1),14)
```

```
"SINH="&FIXED((EXP(theta)-EXP(-theta))/2,8
```

See Also

LN for the natural logarithm of a number.

FALSE()

FALSE()**Description**

Returns the logical value false.

Example

If you are planning on putting a complicated condition into a cell, you can use FALSE() to put a logical value in for testing before you construct the more complicated expression.

See Also

AND, *OR*, and *NOT* to operate on logical values.

IF to test a logical value.

FIXED(N,Digits)

FIXED(N,Digits)

Description

Converts the specified value to text showing a fixed-decimal number with the number of decimal digits specified, just like the “Fix” format code under the Format Cells command in Chapter 9, “Commands.”

If the value is negative, a minus sign is placed before the leftmost digit. If digits is negative, rounding is done to the left of the decimal point.

Requirements

Digits must be an integer between 0 and 30.

Example

```
FIXED((first/second)*100,2)&"percent"
```

See Also

DOLLAR to format money amounts.

VALUE to convert text back to a number.

ROUND to return the number value of rounding.

IF(Logical, Then Value, Else Value)

IF(Logical, Then Value, Else Value)**Description**

If the *Logical* is true, returns the *Then* value. Otherwise, returns the *Else* value. These values may be numeric, text, or logical values.

Example

```
IF(grade>80,"excellent",grade)
```

See Also

AND, *OR*, and *NOT* to operate on logical values.

ISNA and *ISERROR* to check for error values.

INDEX(Area,Subscripts)

INDEX(Area, Subscripts)

Description

Returns the value of a cell selected by Subscripts from the rectangular area.

One or two subscripts may be given. With one subscript, the area must be part of one row or one column. Subscript value 1 selects the first cell in the row or column, value 2 the second cell, and so on.

If two subscripts (separated by commas) are given, the area may be rectangular. The subscripts select the row and column in the area, starting at 1 in each case.

If any index exceeds the limits of the area, the #N/A (not available) error value is returned.

Examples

To repeat the first column in the first row, copy the formula:

```
INDEX(C1,COLUMN())
```

throughout the first row.

If the area Score is a table giving adjusted composite scores for raw scores on two components in a test, then:

```
INDEX(Score,RAW1 C,Raw2 C)
```

will give the appropriate composite score, based on the two raw scores.

INT(N)

INT(N)**Description**

Returns the largest integer less than or equal to N.

Examples

```
"fraction="&FIXED(number-INT(number),4)
```

`INT(6)` is 6

`INT(8.9)` is 8

`INT(-123.999)` is -124

See Also

ROUND to round a number to a certain decimal place.

IRR(List,Guess)

IRR(List,Guess)

Default: *Guess* = 0

Description

IRR calculates the Internal Rate of Return of a *List* of cash flows. IRR is defined as the interest rate such that the Net Present Value of the cash flows is zero.

Multiplan uses an iterative technique to compute IRR, which can have multiple solutions. If convergence to within 0.0000001 does not occur within 20 iterations, the function returns #NUM!. You can specify the initial value of the iteration with the optional argument *Guess*. The default value is *Guess*=0. If IRR does not Converge, try different values for *Guess*. Usually an initial value between 0 and 1 will yield a meaningful result.

Requirements

Express the interest rate *Guess* as a decimal fraction. It must be an N value.

Example

You are considering an investment represented by the following cash flows entered in cells R1C1 through R1C7:

(\$5000.00) \$1000.00 \$1500.00 \$2000.00 (\$3000.00) \$2500.00 \$5000

With 10% as your *Guess* the Internal Rate of Return of the cash flow is given by:

IRR(R1C1:R1C7,0.10)=15.05%

ISERROR(Value)

ISERROR(Value)**Description**

Returns the logical value true if the argument is any of the error values (#N/A, #VALUE!, #REF!, #DIV/0!, #NUM!, #NAME?, #NULL!). Otherwise, returns false.

Example

```
IF(ISERROR(ratio),"check your numbers","")
```

See Also

IF to test a logical value.

ISNA(Value)

ISNA(Value)**Description**

Returns the logical value true if the argument is # N/A (not available). Otherwise, returns false.

Example

```
IF(ISNA(balance),"0",balance)
```

See Also

NA to produce #N/A value.

IF to test a logical value.

ISERROR to test for all error values.

LEN(T)

LEN(T)**Description**

Returns the number of characters in the text value.

Example

`MID(T,LEN(T),1)`

is the last character of the text *T*.

See Also

MID to return specified characters from a text value.

LN(N)

LN(N)

Description

Calculates the natural logarithm of the argument.

Requirements

N must be positive. A #NUM! error value is returned if *N* is less than or equal to zero.

Example

```
"log2="&FIXED(LN(value)/LN(2),8)
```

See Also

ABS to ensure that the argument is positive.

EXP for the inverse of LN.

LOG10 for logarithms to the base 10.

LOG10(N)

LOG10(N)**Description**

Calculates the base 10 logarithm of the argument.

Requirements

N must be positive. A #NUM! error value is returned if *N* is negative.

Example

"Order of Magnitude: "&FIXED(LOG10(value),0)

See Also

ABS to ensure that the argument is positive.

LN for logarithms to the base *e* and other bases.

LOOKUP(N,Table)

LOOKUP(N,Table)

Description

Searches for N in the first row or column of Table. Returns the contents of a cell from the last row or column of Table. Table is a group of cells on the worksheet.

The dimensions of Table determine the direction of the search.

If Table is square, or higher than it is wide, Multiplan searches in the first column of Table until it finds the cell that has the largest value that is less than or equal to N . The value in the last cell in that row of Table is returned as the result of the function. If the values in all cells in the first column are less than N , the last row of Table is used. If the values in all cells in the first column are greater than N , a #N/A value is returned.

If Table is wider than it is high (has more columns than it has rows), then Multiplan searches for N in the first row of Table. The value in the last cell in that column of Table is returned as the result of the function. If the values in all cells in the first row are less than N , the last column of Table is used. If the values in all cells in the first row are greater than N , a #N/A value is returned.

Requirements

Table should be a cell reference to a rectangular area in the active worksheet. The result returned may be either a number value, a text value, or a logical value.

LOOKUP expects that you entered the values in the first row or column in ascending order. If values are not in ascending order, LOOKUP may return either the #VALUE! or #N/A error value.

Example

Assume that column 1 (C1) lists base salaries, column 2 (C2) lists minimum tax, and column 3 (C3) lists marginal tax rates as percents:

C1	C2	C3
0	0	0%
2300	0	14%
3400	154	16%
4400	314	18%
6500	692	19%
8500	1072	21%
...

Also assume that a name *Salary* has been defined and that it contains a value *N*.

The tax on a salary in one of the brackets in Table can be expressed as:

$$\text{LOOKUP}(\text{salary}, \text{C1}; \text{C2}) + (\text{salary} - \text{LOOKUP}(\text{Salary}, \text{C1})) * \text{LOOKUP}(\text{Salary}, \text{C1}; \text{C3})$$

Notice that in the first lookup, we find the tax on the “base” amount (using C1 to find a value in C2). In the second lookup, we find the actual base amount (using C1 to find a value in itself; in fact, Table can be one column wide or one row high). And in the third lookup, we find the marginal tax rate for the amount of the salary that exceeds the base amount (using C1 to find a value in C3).

MAX(List)

MAX(List)

Description

Returns the largest number value from *List*. Returns zero if *List* represents no number values.

Example

```
"Best of"&FIXED(COUNT(scores),0)&  
"is"&FIXED(MAX(scores),2)
```

See Also

MIN for the minimum of two or more values.

MID(T,Start,Count)**MID(T,Start,Count)****Description**

Returns specified characters from *T*.

Start specifies the position of the first character of *T* to be taken, counted from the left end of *T*. The first character is position 1.

Count specifies the number of characters to be taken.

If *Count* is zero, or if *Start* is greater than the length of the result of *T*, no characters are returned.

If *Count* is negative, a #VALUE! error value is returned.

Requirements

Start and *Count* must be *N* values. If either *Start* or *Count* has a fraction, the fraction part is truncated before the integer part is used.

Example

```
MID("FFFFFFDCBAA",INT(grade/10),1)
```

See Also

LEN for the length of the text value.

MIN(List)

MIN(List)

Description

Returns the smallest number value from *List*.

Example

```
"Lowest of "&FIXED(COUNT(times),0)&  
"is"&FIXED(MIN(times),0)
```

See Also

MAX for the maximum of two or more values.

MIRR(List, Safe, Risk)**MIRR(List, Safe, Risk)****Description**

MIRR calculates the Modified Internal Rate of Return of a *List* of cash flows, given the *Safe* rate returned by the investment that will finance the negative cash flows, and the *Risk* rate at which the positive cash flows can be reinvested.

Where *n* is the number of cash flows in *List*, the formula used is:

$$\text{MIRR}(\text{list}, \text{safe}, \text{risk}) = \left(\frac{-\text{NPV}(\text{risk}, \text{list}_+) \cdot (1 + \text{risk})^n}{\text{NPV}(\text{safe}, \text{list}_-) \cdot (1 + \text{safe})} \right)^{\frac{1}{n-1}} - 1$$

Requirements

Express the interest rates *Safe* and *Risk* as decimal fractions. They must be *N* values.

Example

You are considering an investment with the following cash flows entered in cells R1C1 through R1C7:

(\$5000.00) \$1000.00 \$1500.00 \$2000.00 (\$3000.00) \$2500.00 \$5000

You plan to finance the negative cash flows with an investment earning 12%, and hope to reinvest your positive cash flows at 17%. The Modified Internal Rate of Return of the investment is given by:

`MIRR(R1C1:R1C7,0.12,0.17)=15.19%`

NOT**MOD(Dividend,Divisor)****MOD(Dividend,Divisor)****Descr****Description**Returns
argument is tr

Returns the remainder of Dividend divided by Divisor. The result has the same sign as Divisor.

Exam**Requirements**

IF(OR(c

Both parts of the argument must be an *N* value. If Divisor is zero, a #DIV/0! error value is returned.where
necess**Examples**

```

MOD(3,2)=1
MOD(-3,2)=-1
MOD(-3,-2)=-1
MOD(3,-2)=-1

```

See A**AND z****IF to t**In general: $\text{MOD}(x,y)=x-\text{INT}(x/y)*y$

NA()

NPV(Rate,List)

NPV(Rate,List)**Description**

Net Present Value (NPV) calculates the amount of money required now to produce a specified cash flow in the future, given some interest rate.

The formula used is:

$$\sum_{i=1}^n \frac{\text{list}_i}{(1+\text{rate})^i}$$

Requirements

Rate is an interest rate, expressed as a decimal fraction (0.11 is a rate of 11%). It must be an *N* value.

The first value represented by *List* is income required at the end of the first period, the second the income required at the end of the next period, and so on.

Example

You are given the opportunity to lease a parking lot for five years for an \$80,000 one-time payment. The lot currently generates \$15,000 net operating income annually. Based on research and profit studies you have done, you expect the income to increase 30% annually.

Place \$15,000 in cell R1C1. Place R[-1]C*1.3 in cell R2C1, and copy it right to the next three cells. Name the area Flow. Now, you can figure the net present value of the cash flow.

If your opportunity rate is 15%, then NPV(15%,Flow) gives you the present value of \$84,598.24. Since this is greater than the cost of the lease, you conclude that it is a worthwhile investment.

OR(List)

OR(List)

Description

Returns the logical value true if any value in *List* is true. Otherwise, returns false.

Requirements

The argument entries must be logical values. If not, the #VALUE! error value is returned.

Example

```
IF(OR(grade>80,final)=150,"good work","")
```

See Also

AND and *NOT* to operate on logical values.

IF to test a logical value.

PI()

PI()

Description

Returns the value 3.1415926535898, an approximation of the mathematical constant π .

Example

`SIN(PI()/4)`

PV(Rate,Nper,Pmt,Fv,T)defaults: $Fv=0$ $T=0$ **PV, FV, NPER, PMT,
RATE****FV(Rate,Nper,Pmt,Pv,T)**defaults: $Pv=0$ $T=0$ **NPER(Rate,Pmt,Pv,Fv,T)**defaults: $Fv=0$ $T=0$ **PMT(Rate,Nper,Pv,Fv,T)**defaults: $Fv=0$ $T=0$ **RATE(Nper,Pmt,Pv,Fv,T,Guess)**defaults: $Fv=0$ $T=0$ $Guess=0$ **Description**

Present Value (Pv), Future Value (Fv), Periodic Payment (Pmt), Number of Periods (Nper), and Interest Rate per Period (Rate) are the five standard financial arguments in cash flow problems involving constant payments. Each of the above functions returns the value of one of these financial arguments, given the values of the others.

Some of the arguments have default values (shown above). If you do not specify a value for such an argument, the default value will be used.

The optional argument T in each function allows you to specify whether payments are made at the beginning or the end of the periods. If $T=0$, payments are made at the end; if $T=1$, payments are made at the beginning. The default value is $T=0$.

Multiplan uses an iterative technique to compute Rate, which can have zero, one, or two solutions.

If convergence to within 0.0000001 does not occur within 20 iterations, the function returns *#NUM!*. You can specify the initial value of the iteration with the optional argument *Guess*. The default value is $Guess=0$. If Rate does not converge, try different values for *Guess*. Usually, an initial value between 0 and 1 will yield a meaningful result.

For the arguments Pv , Fv , and Pmt , use the following cash flow convention: cash received is represented by a positive value; cash paid out is represented by a negative value. The examples below illustrate this convention.

Finally, the arguments, $Rate$ and $Nper$ must correspond to the same period. For example, if $Nper$ is the number of months, then $Rate$ must be the effective monthly interest rate.

Multiplan uses the following equations for these financial functions to solve for one financial argument in terms of the others:

$$pv \cdot (1+rate)^{nper} + pmt \cdot (1+rate)^t \frac{(1+rate)^{nper} - 1}{rate} + fv = 0 \quad i < > 0$$

$$pv \cdot (1+rate)^{nper} + pmt \cdot (1+rate)^t \cdot nper + fv = 0 \quad i = 0$$

Requirements

Express the interest rates $Rate$ and $Guess$ as decimal fractions. $Rate$, $Nper$, Pmt , Pv , Fv , T , and $Guess$ must all be N values.

Examples

Problem: What is the monthly payment on a \$12,000 loan at 9% annual interest, if the loan is to be paid off in 2 years?

Solution: You have received a loan of 12,000 (Pv), at a monthly interest rate of 0.75% ($Rate$), and must pay off the loan in 24 ($Nper$) monthly payments made at the end of each month ($T=0$). The monthly payment is given by:

$$PMT(0.0075, 24, 12000) = (\$548.22)$$

Problem: A limited partnership plans to buy an apartment building for \$750,000 with the expectation of selling the building for \$1,500,000 in 6 years. If the rent from the apartments amounts to \$100,000 annually, what annual rate of return will the investment yield?

Solution: You will pay $-750,000$ (Pv) at the beginning of the investment, receive $100,000$ (Pmt) at the end of each year ($T=0$) for the next 6 ($Nper$) years, and receive another $1,500,000$ (Fv) at the end of the investment. With 10% as your initial $Guess$ at the annual rate of return, the annual rate of return on the investment is given by:

$$RATE(6, 100000, -750000, 1500000, 0, 0.10) = 22.73\%$$

Problem: Suppose you now have \$1000 in your savings account earning 6% annual interest, and you plan to deposit \$100 at the beginning of every month for the next 12 months. How much will you have in your savings account at the end of the 12 months?

Solution: You have already deposited -1,000 (Pv) in an account earning 0.5% (Rate) monthly interest, and you will deposit an additional -100 (Pmt) at the beginning of every month ($T=1$) for the next 12 (Nper) months. The future value of your account at the end of the 12 months is given by:

$$FV(0.005,12,-100,-1000,1) = \$2301.40$$

REPT(T,Count)

REPT(T,Count)**Description**

Returns a text value consisting of Count repetitions of *T*. If Count is zero or negative, #VALUE! is returned. Otherwise, the length of the result will be the length of *T* multiplied by Count.

This function may be used to create bar graphs, or repeating patterns (such as printer's rules) to separate areas of the worksheet.

Requirements

T is usually a single character, but it may be any number of characters.

Count must be an *N* value, which will be truncated to an integer.

Example

REPT("+",Score/3)

ROUND(N,Digits)

ROUND(N,Digits)

Description

Returns a value, rounded to the number of decimal places specified by Digits.

Digits specifies the rounding as follows:

- If Digits is greater than zero, then the result will be rounded to that many decimal places. For example, ROUND(3.1416,3) produces 3.142.
- If Digits is zero, the result is rounded to an integer.
- If Digits is negative, rounding is carried into the integer. For example, ROUND(21,-1) produces 20 while ROUND(991,-2) produces 1000.

Requirements

Digits must be an *N* value.

Example

Balance+ROUND(Balance*Interest/12,2)

See Also

INT to return the integer part of a number.

ROW()

ROW()**Description**

Returns the number of the row in which the formula containing this function appears.

Example

Copying the expression `ROW()*10` throughout the first column creates the sequence of numbers:

```
10  
20  
30  
...
```

See Also

COLUMN for the current column number.

SIGN(N)

SIGN(N)

Description

Returns a number representing the algebraic sign of the argument.

If the sign of the argument is positive, the function returns 1.

If the argument value is zero, the function returns 0.

If the sign of the argument is negative, the function returns -1 .

Example

To display the magnitude of a number in bar chart form and its sign:

```
REPT(MID('-',SIGN(num)+2,1),ABS(num))
```

See Also

ABS to return the absolute value of a number.

SIN(N)

SIN(N)**Description**

Calculates the sine of the argument, an angle in radians.

Example

`SIN(the arrow C)`

See Also

COS and *TAN* for the other trigonometric functions.

SQRT(N)**SQRT(N)****Description**

Returns the square root of the argument.

Requirement

N must be positive. If *N* is negative, a #NUM! error value is returned.

Example

`SQRT(x*x+y*y)`

STDEV(List)

STDEV(List)**Description**

Calculates the sample standard deviation of the number values represented by *List* according to the formula:

$$s = \sqrt{\frac{\sum x^2 - \frac{(\sum x)^2}{n}}{n - 1}}$$

Example

STDEV(grades)

See Also

AVERAGE for the average value.

SUM(List)

SUM(List)

Description

Returns the sum of number values represented by *List*.

Example

$(1+rate)*SUM(\text{deposits January})$

See Also

MAX for the maximum of two or more values.

MIN for the minimum of two or more values.

AVERAGE for the average value.

COUNT for the count of the number values.

TAN(N)

TAN(N)**Description**

Calculates the tangent of the argument, an angle in radians.

Example

```
TAN(1)  ← 1.5574077246549023
```

See Also

COS and *SIN* for the other trigonometric functions.

ATAN for the inverse tangent function.

TRUE()

TRUE()

Description

Returns the logical value true.

Example

If you are planning on putting a complicated condition into a cell, you can use `TRUE()` to put a logical value in for testing before you construct the more complicated expression.

See Also

AND, *OR*, and *NOT* to operate on logical values.

IF to test a logical value.

Value(T)

VALUE(T)**Description**

Returns the number in the argument, represented as text. The argument must be the text form of a number, similar to those produced by the formatting codes used by Multiplan. It may contain a leading dollar sign or a leading minus sign. It may be written in scientific notation.

For example, all the following text forms yield the value 10: 10, \$10.00, 1E1. The following text forms yield negative 10: -10, -1E1.

Requirements

If the contents of *T* do not describe a number—if they include letters, for instance, or two decimal points—a #VALUE! error value is returned. You can avoid this problem by first isolating numbers mixed with nonnumeric characters, as the example below shows.

Example

Suppose that the cell named *date* contains the text "6/14/83". Then:

```
VALUE(MID(date,3,2))
```

returns the number 14.

11 Messages

The following directory lists in alphabetical order all the possible messages that Multiplan may display, along with descriptions of possible causes and what actions you may take in response to them.

Cannot copy into non-blank cell

- The destination area of an eXternal Copy contains a nonblank cell.
Review the response to the eXternal Copy command. Make sure that the destination area you specify is not used for any other purpose. If appropriate, blank the cells that are not blank.

Cannot link those windows

- An attempt was made to link two windows that were not split from each other. Also occurs on unlinking, especially unlinking a Title split.
Refer to the Window Link command in Chapter 9, "Commands."

Cannot read file

- Confirms a negative response to the "Enter Y to retry access to *filename*" message. May also appear after the directory display is requested, but an unknown file was named.
No special action is necessary. See the "Files" section in Chapter 8, "Elements of Multiplan," for more information.

Cannot write file

- The file last named is available but cannot be written to disk; either because (1) the diskette is full, or (2) the diskette is write-protected.
First, save your work on a different diskette. Check the available space and write-protection of the diskette that caused the error message. See the "Files" section in Chapter 8, "Elements of Multiplan," and the section at the beginning of this volume entitled "Operating Information" for more information.

Cell locked by eXternal Copy

- Either an attempt was made to unlock a cell that is the destination of a linked eXternal Copy, or an attempt was made to copy from an area of the worksheet that is the destination of a linked eXternal Copy.

Such cells must not be changed, for any change would be erased the next time the sheets were loaded and the external copies executed. To regain access to the cell, exclude it from copying. Redefine the eXternal Copy command accordingly.

Cells to recalculate: *number*

- You entered a new value into the worksheet while Multiplan was in automatic recalculation mode, or you pressed the RECALC key (!) after entering a new value while Multiplan was not in automatic recalculation mode. This message appears only if there are more than a couple of dozen cells to be recalculated. Simply watch the *number* count down to zero. The number tells you where Multiplan is in the recalculation. When the number reaches zero, you can continue your Multiplan session.

Circular references unresolved: *cell reference*

- Cells refer to each other in a chain so that the last refers back to the first. (The simplest case is a cell containing a reference to itself—RC—but the chain may be many steps long.) Multiplan has calculated all the cells of the chain once and found itself starting over. It stops calculating, leaving the cells in the circular chain in an undefined state.

Alter the logic of the sheet so that there is no circularity. Use the same methods described in the “Formulas” section of Chapter 8, “Elements of Multiplan,” for finding the source of error values.

Confirm change: *sheet name reference*

- The name of an area, which is the source of a linked eXternal Copy, has been changed on the supporting sheet. Copying will not take place. The system will wait for a character to be typed.

Type any character. The rest of the specified files, if any, will be loaded. Review the eXternal Copy command in light of the change on the supporting sheet. Redefine the eXternal Copy command as appropriate.

Copying: *filename reference*

- You are loading a worksheet with links to other worksheets. This message shows which supporting sheets, and which areas within those sheets, Multiplan is copying. No action required. You can continue when Multiplan finishes copying.

Disk error

- While attempting to read or write a file, Multiplan was told of a serious error by the operating system.
See the “Files” section in Chapter 8, “Elements of Multiplan,” for possible problems with reading or writing files.

Disk full

- There is no more room on the diskette.
Use the Transfer Delete command to look at the file directory on the diskette, and delete unneeded files. As an alternative, use a different diskette.

Enter color number or use direction keys to select from list

- A command field of the Window Paint command requires a color number from the list of available colors.
Type the number of the color you want. Or, press UP, DOWN, LEFT, or RIGHT to request and select from the list of available colors. Press CANCEL to return the worksheet to the original colors.

Enter filename, or use direction keys to select from list

- The active field of the command takes the name of a file to be written.
Enter a filename, or press CANCEL to cancel the command.
- The active field of the command takes a filename existing on a disk.
If you know the name of the file desired, enter it. If you want to examine the names of all saved sheets, use the direction keys as described under the Transfer Load command in Chapter 9, “Commands.” Or, press CANCEL to cancel the command.

Enter formula

- Multiplan awaits a formula. The direction keys can be used to put a reference into the formula.
Enter a formula, a number, or text (enclosed in quotation marks), or press CANCEL to cancel the command.

Enter name

- The active field of the command takes a name. See the Name command in Chapter 9, “Commands,” for the rules governing names.
Enter a name, or press CANCEL to cancel the command.

Enter name on external sheet or use direction keys to select from list

- The “name” field of the eXternal Copy command requires the name of the area you want to copy into your active worksheet.
Enter a name, or press CANCEL to cancel the command.

Enter number

- The active field of the command takes a single number: a row or column number, or a quantity, such as margin spacing. Enter a number or press CANCEL to cancel the command. Note that it is possible to enter a formula, though it must result in a small integer.

Enter number, or d for default

- In the Format Width command, the width of a column can be set to a specific width in characters, or to the width set by the Format Default Width command. Enter a number from 3 to 32, or the letter *d*, or press CANCEL to cancel the command.

Enter reference to cell or group of cells

- The active field of the command takes a reference of any kind, including a range, intersection, or a list (a union) of references. Enter a reference to a cell (or cells), or press CANCEL to cancel the command. The direction keys may be used to enter references to particular cells.

Enter text

- The active field of the command takes text. Double quotation marks are not permitted because they are used to delimit text in formulas. Enter text, or press CANCEL to cancel the command.

Enter text or value

- You press a cursor movement key (such as a direction key) following either the Alpha command or Value command or Edit command. If you want to enter additional data, simply type what you want entered. Multiplan automatically selects the appropriate command (Alpha or Value). If you want to return to the main command menu, press CANCEL. If you press RETURN instead of a cursor movement key following these three commands, Multiplan returns to the main command menu as soon as the command is carried out.

Enter Y to confirm

- You have asked Multiplan to make a major change in the active sheet. Please carefully consider whether this action is correct. If it is safe for the command to proceed, type a *Y*. If it is not safe, press any other character, and Multiplan will return to the main command menu without changing the worksheet.

Enter Y to overwrite file

- The disk file Multiplan is about to create—either a saved worksheet or a file of printer lines from the Print File command—has the same name as an existing file. If Multiplan continues, it will replace the existing file with the new one. Think carefully! If you agree that the existing file is of no importance, reply *Y* to let the command proceed. If the file might be important, reply *N* and reenter the command giving a different, unique filename.

Enter Y to retry access to *filename*

- The file named is not accessible to Multiplan. Enter *N* if the file is not appropriate. Make sure that the correct diskette is mounted in the correct drive. Change the “default drive” if necessary. See the “Files” section in Chapter 8, “Elements of Multiplan,” and the section at the beginning of this manual entitled “Operating Information” for more information. Then try *Y* again. If you still get this message, *N* cancels the command and returns the main command menu and worksheet display.

Enter Y to save edits, N to lose edits, or cancel

- You have chosen the Quit command and one or more worksheets have unsaved edits. Press *Y* to save the worksheet as currently displayed in the window; then quit Multiplan. Press *N* to quit Multiplan without saving your revisions. Press CANCEL to cancel the Quit command and continue working with Multiplan.

File format error: line *number*

- File being read is in the incorrect format. The file read stopped at the line number displayed. Check the mode setting of the Transfer Options command. Be sure that the mode setting is the same as the format of the file being read.

File is not a saved worksheet

- The file you are trying to load or link to was not saved with the Transfer Save command. Check the spelling of the filename. Make sure the “mode” of the transfer is correct if you are trying to load other than Normal format files.

Help file not available

- The disk file containing the on-line reference information cannot be found. See the “Files” section in Chapter 8, “Elements of Multiplan.”

F

H

S

Saving file...

- Multiplan is saving the worksheet with the Transfer Save command.

When the save is finished, you can continue to work.

Select option

- Multiplan is waiting for your choice among a short list of options.

Selection in this case is similar to command selection. Move the edit cursor to the desired option using the SPACE and BACKSPACE keys (as necessary). Or, type the initial letter of the option.

Select option or type command letter

- Multiplan awaits your choice from a list of options.

Select one of the items shown by moving the edit cursor to it with the SPACE and BACKSPACE keys, then pressing RETURN. Or, just type the initial letter of the item you want.

Shapes of areas do not match

- The destination area of an eXternal Copy command does not have the same "shape" (size) as the source area.

Specify a single cell as the upper left corner of the destination to suppress the shape check. However, the mismatch suggests a review of the names on the supporting sheet and on the active sheet.

T

Too many depending sheets

- Multiplan can keep track of eight dependent sheets at most. The message signals that there are more than eight dependent sheets.

No action is necessary, but you cannot rely on the accuracy of the eXternal List command. See also the discussion of eXternal Relationships in the "Files" section in Chapter 8, "Elements of Multiplan."

Too many windows

- There is a limit of eight windows and the Window Split command has been used in an attempt to open a ninth.

Review the existing windows; use the Window Close command to delete some of them.

W

Window will not fit

- The window you are trying to Border or Split is too small.

Close an adjacent window to get more room on the screen, or rethink your screen layout.

Appendices

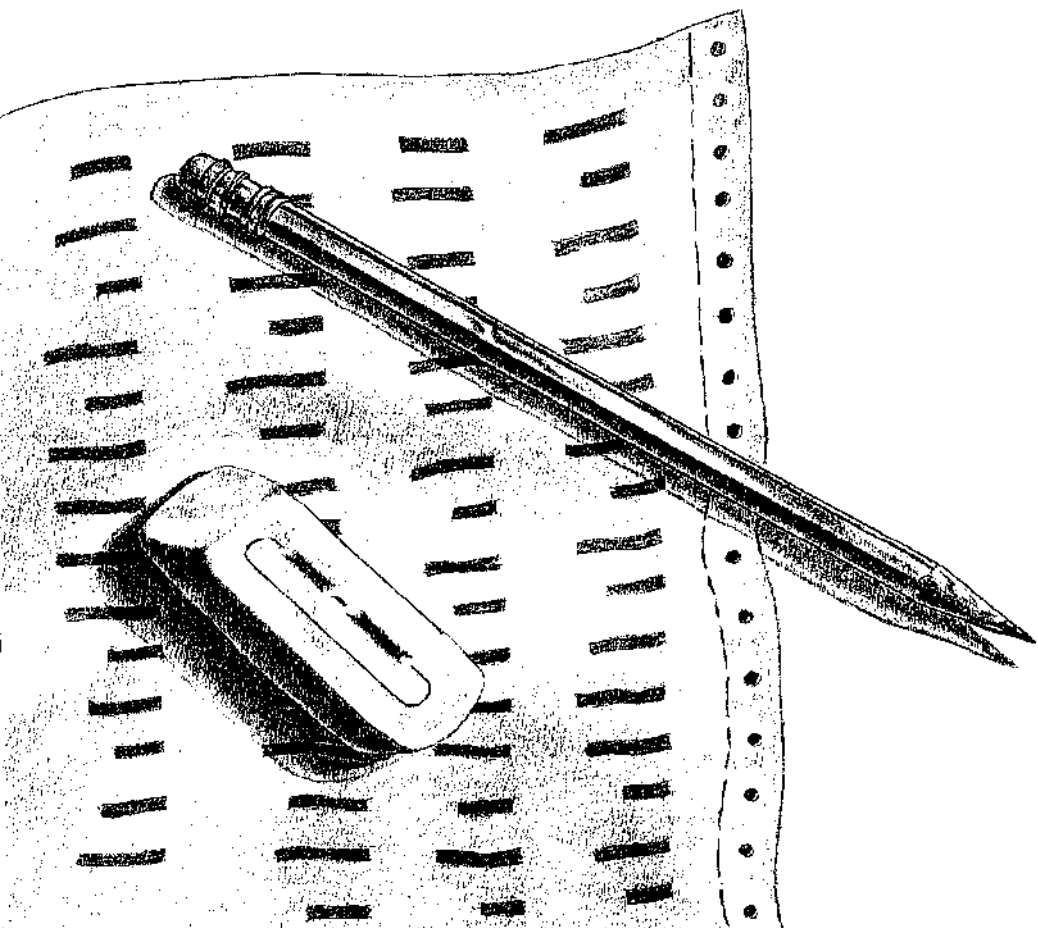

Appendices

The appendices in this part will give you more information on:

A. Macros

B. Solving Extended Problems with the Iteration Option

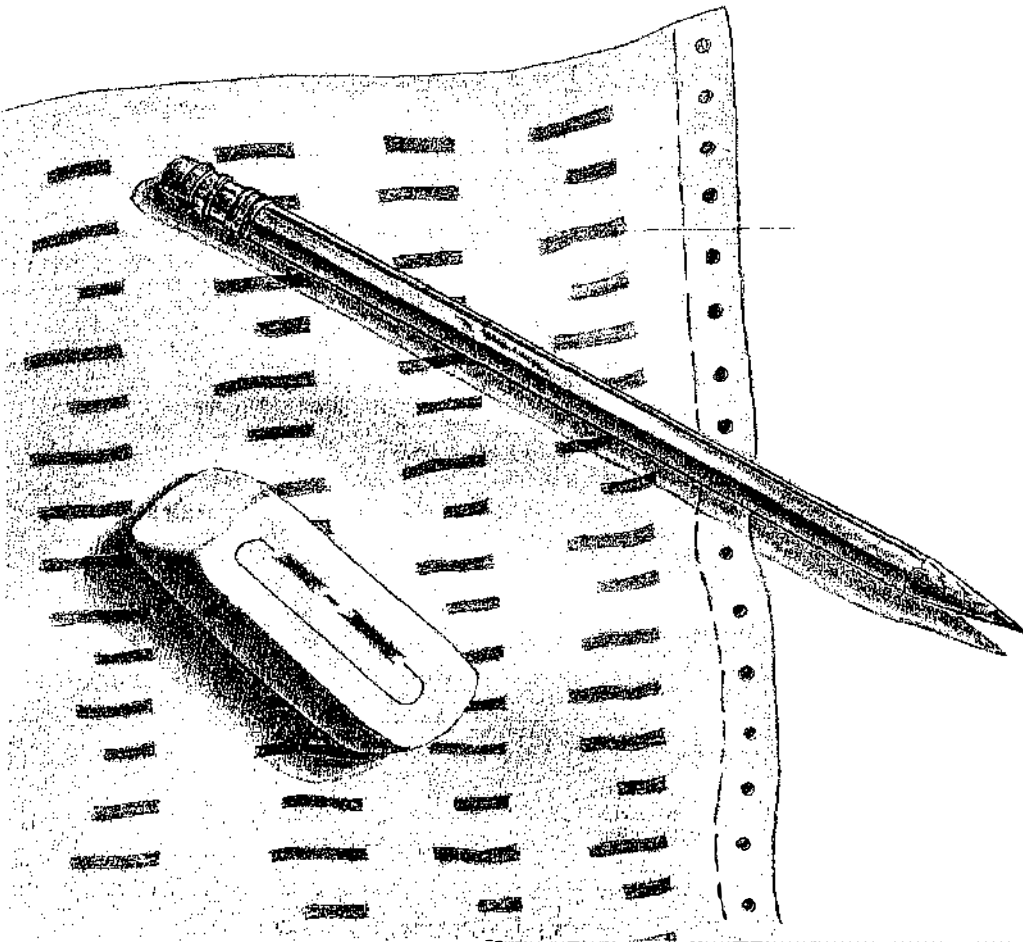



1

2

3

Appendix A

Macros

As you become experienced in using Multiplan you may find that you use the same keystrokes over and over. Or you may want others to enter data in a worksheet, but you can't afford the time to train them. These are just two of the many situations that you can improve by using an advanced feature called keyboard macros, or "macros."

A macro is a cell or group of cells containing a series of keystrokes. You store the keystroke sequences that you use regularly in a macro. Then, instead of typing the keystroke sequence each time, you run the macro and let it type the keys for you.

This appendix shows you how to write and use macros. First you will try a simple macro. Then you will find more detailed directions on writing macros, as well as information on the other macro features available. This is followed by an example of a more advanced macro that uses some of these features.

A Simple Example

In "Using Multiplan" you worked through a set of examples that dealt with a model company named Spencer Ceramics. The following example is based on the Spencer worksheet. To see how macros work, try the following example.

The worksheet you have been working on for Spencer Ceramics is very detailed. You can account for every penny. But perhaps your boss doesn't want that much detail in your weekly progress reports. He would rather have figures rounded off to the nearest dollar.

On the other hand, accountants require that you account for every last cent in weekly reports to them. You are getting tired of reformatting all the time, so you decide to write a couple of macros to do it for you.

Normally, to reformat for the boss, you would use the following keystrokes:

Keystroke	Task
f	for FORMAT
d	for DEFAULT
c	for CELLS
TAB	to move from "alignment" to "format code"
\$	for \$ format
TAB	to move from "format code" to "# of decimals"
0	to change to zero decimal places
RETURN	to carry out the command

Write the macro

Try writing a macro instead:

- 1 Go to a cell that is out of the way, like R200C20.
- 2 Press A for Alpha, to enter text.
- 3 Type the following characters to represent the above key sequence:

```
f d c ' t b $ ' t b 0 ' r t
```

Note Do not leave blank spaces between the letters, just as you would not type spaces when typing in command mode. Blank spaces between letters are read as blank spaces, and will produce different results in the macro.

- 4 Press RETURN.

You have now defined the macro.

You will notice that two of the keys you needed, TAB and RETURN, were not directly entered. This is because of the function each performs. For these and a number of other keys, you have to type an apostrophe followed by two letters, called a "key code." A complete list of these codes can be found later in this appendix.

Now that you have defined the macro, name it with the Name command.

- 1 Press N for Name.
- 2 Type in a name for the macro, like *bossformat*.
- 3 Press the TAB key.
- 4 Identify the cell containing the macro. You can either select the cell with the direction keys or type the cell reference.
- 5 Press the TAB key.
- 6 Type Y to identify it as a macro.
- 7 Press the TAB key.
- 8 Type a two letter command key sequence, like *bf*.
- 9 Press RETURN to carry out the Name command.

You have now given the macro a name and attached a command key sequence.

You can run the macro at any time by holding down the ALTERNATE key and typing *bf*.

You can write an identical macro, *acctformat*, that has a 2 instead of a zero in the “# of decimals” field. This macro formats the worksheet for the accountant. Now all you have to do to change the format is type the appropriate command key sequence.

Name the macro

Run the macro

Creating Macros

As you saw in the example, there are three steps in creating and using a macro:

- 1 Writing the macro
- 2 Naming the macro
- 3 Running the macro

Once you have created and named a macro, you can run it whenever you want. Remember, however, that the macro will only work for a spreadsheet that contains the macro. Use the eXternal Copy command to copy a macro to other worksheets.

Writing a Macro

When you write a macro, you should start in an out-of-the-way cell. You have enough room in Multiplan to place macros where they won't interfere with any of your sheets.

Writing macros

Each cell can hold up to 255 characters, enough to hold a fairly large macro. However, it is better to organize your macros by breaking them down into separate tasks, and putting each task into a succeeding cell in the column. Macros broken down this way are easier to test, debug, understand, and change.

Although you can't insert extra blank spaces in a macro, leading and trailing blank spaces in each cell are ignored, which means that you don't have to fill each cell completely before going to the next.

In a macro, cells are read downward in a column. If you use more than one cell in your macro, put each succeeding cell below the previous one. If you prefer to have a macro read differently, you can redirect how it is read with the 'GO command code, described later in this appendix. The macro will continue running at the named cell.

You can include other macros in a macro by using the 'CA ("call") command code. Command codes are covered later in this appendix.

A number of keys cannot be directly entered into a macro because of the function each performs. For these keys, you must enter an apostrophe followed by a two-letter code. Key codes can be upper or lower case. These key codes are listed below:

Key	Keycode
Backspace	'bs
Character left	'cl
Cancel	'cn
Character right	'cr
Change window	'cw
Down	'dk
Delete	'dl
End	'en
Help	'hp
Home	'hm
Home window	'hw
Left	'lk
Next unlocked cell	'nu
Previous unlocked cell	'pc
Page down	'pd
Previous field or back tab	'pf
Page left	'pl
Page right	'pr
Page up	'pu
Previous window	'pw
Recalc	'rc
Reference	'rf

Key codes

Right	'rk
Return	'rt
Space bar	'sp
Tab	'tb
Up	'uk
Word left	'wl
Word right	'wr

There is another way to enter key codes. Instead of typing an apostrophe and the two-letter key code, you can use the EDIT MACRO key.

When you press the EDIT MACRO key, you suspend the normal action of the keys and insert their key codes into the macro instead. For example, if you press the EDIT MACRO key and then the tab key, 'tb will be entered into the macro you are writing. Press the EDIT MACRO key a second time to resume normal key actions. *EM* appears in the status line when you are in the Edit Macro mode.

If you create long or complex macros, you will find it helpful to add comments. Then, if you want to go back later to change or copy part of the macro, you will have built-in reminders of what the macro does. You can add comments two ways:

- Type the text of the comments into cells in the columns next to the macro. As long as you don't try to use these cells as macros, Multiplan will ignore them.
- Embed comments into the macro using the 'LA command code. The comments will be ignored when you run the macro. This method of adding comments is especially useful if you want to create a macro more than one column wide. See the "Command Codes" section below for a description of 'LA.

You can end a macro in either of two ways, with a blank cell or the 'QU command. However, it is usually best to use the 'QU command to be certain that the macro ends where you want it to.

Naming the Macro

It is not strictly necessary to name a macro, because any macro can be accessed through the upper left cell of the range it occupies. However, a named macro is easier to copy to another sheet, easier to remember, and easier to find if you forget. To find an unnamed macro, you would have to search the entire sheet. To find a named macro, you can use the Goto Name command.

The EDIT MACRO key

Adding comments

Ending macros

Naming macros

When you name a macro, you give it both a regular name and a control key sequence:

- 1 Press N for Name.
- 2 Type a name for the macro.
- 3 Select the entire range of cells containing the macro.
- 4 Press the TAB key.
- 5 Type Y to identify this as a macro name.
- 6 Press the TAB key.
- 7 Type in a two-letter command key sequence.
- 8 Press RETURN.

Command key sequences

You can run a macro quickly by typing its command key sequence. If you forget a command key sequence, you can find it by going through the macro enumeration list in the Name command.

Important When you attach a command key sequence to a macro, avoid using the letter h as the first letter. If you assign a macro a command key sequence that starts with an h, you will no longer be able to get help by using ALTERNATE-h.

Running a Macro

Running macros

The easiest way to run a macro is to use its command key sequence:

- While holding down the ALTERNATE key, type the command key sequence you defined when you named the macro.

You can also run a macro by using the Goto Macro command:

- 1 Press G for Goto.
- 2 Press M for Macro.
- 3 Type the name of the macro, or use the direction keys to select the desired macro from the enumeration list. If you didn't name the macro, type the reference of the upper left cell in the macro's range.
- 4 Press RETURN to run the macro.

You can halt a macro at any time by pressing the CANCEL key.

Editing a Macro

Now matter how simple your macros are, you will probably need to edit them at some time. You edit a macro the same way you edit the contents of any other cell. See Chapter 8, "Elements of Multiplan," for more details on editing the contents of a cell.

Note You can go to the cell by scrolling or by using either the macro's name or the reference of the upper left cell of its range while in the Goto command. If you use the Goto command, you *must* use the Goto Name command. If you use the Goto Macro command, you will run the macro without going to it. Goto Name will go to the macro without running it.

Sometimes a macro doesn't work exactly the way you planned it. If you can't figure out why a macro is misbehaving, you can run it one step at a time:

- 1 Press the SINGLE-STEP key. The letters *ST* will appear in the status line when you are in single-step mode.
- 2 Start the macro.
The macro will run the first step and pause.
- 3 Press any key to run the next step of the macro.

The macro will continue to run one step at a time, pausing and waiting for you to press another key to run the next step. You can press CANCEL at any time to stop running the macro. You can press the SINGLE-STEP key between steps to resume normal running of the macro.

An Autoexec Macro

Whenever you load a worksheet, Multiplan checks to see if there is a macro named autoexec in that sheet. If you have written a macro and named it autoexec, it will automatically be run when you load the spreadsheet.

There are a number of useful things you can do with an autoexec macro:

Canceling macros

Editing macros

Single-step mode

Autoexec macros

- Go directly to an updating macro like the example in the next section of this appendix.
- Immediately display a menu that you have created with the `'mn` command code. Such a menu could include choices like Update Data, Print Report, or Reformat (using one of the macros in the example at the beginning of this appendix).
- Immediately display a message. This message can be a reminder to yourself, or instructions to someone else using the worksheet.
- Immediately run some other interactive macro.

Putting interactive macros into an autoexec macro can do more than help you simplify your work. By writing an interactive autoexec macro, you can have others do work on your worksheet for you, without having to train them. This is demonstrated in "A Second Example" later in this appendix.

Interactive Macros

Interactive macros

You can make your macros interact with you or whomever uses them by inserting `'?` into the macro. When a running macro encounters `'?`, it will pause at that point, display *CM* in the status line, and wait for you to type something and press the RETURN key. The RETURN key is not processed as part of the input; it simply signals the macro to continue running. If you want to have a RETURN processed as part of the macro, you would have to add the `'rt` key code.

For instance, in the example at the beginning of this appendix you wrote two macros that were identical except for one key, the number of decimal places. To make one of those macros interactive, replace the number with `'?`. Now if you run the macro, it will select all choices up to the "# of decimals" field, and then pause. All you have to do is type the desired number into that field and press the RETURN key.

An interactive macro such as this can do the work of two or more macros, thus reducing the number of macros you have to keep track of. In the example at the beginning of this appendix, one interactive macro could take the place of the two format macros.

Some of the command codes are also interactive.

Command Codes

Command codes give you rudimentary programming capabilities. By inserting command codes into macros, you can create your own menus, display messages, or make Multiplan interact with the user. The list below shows what you type into the macro and what happens when Multiplan comes across that command code in a macro.

When you use command codes, make sure to include the apostrophes in the appropriate places. Command codes can be either upper- or lower-case.

'IF condition You use the 'IF command for branching based on a condition. If the condition is TRUE, Multiplan continues reading in the same cell. If the condition is FALSE, Multiplan moves to the next cell down to continue reading. See the example under 'GO below.

'GO cell reference Normally, Multiplan reads cells in a macro downward in a column. You use the 'GO command to redirect the normal running of a macro. Multiplan goes to the specified cell and continues running there.

```
'ifAND(R1C1<0, R1C1>4)"goR100C100'
```

In this example, if the value in the cell at row 1, column 1 is greater than zero AND less than four, Multiplan will go to the cell in row 100, column 100, and continue with the contents of that cell. If the condition is FALSE, the 'go command will be ignored, and Multiplan will move down to the next cell and continue reading there.

'CA cell reference The "call" command gives you the ability to use other macros as subroutines. Multiplan will continue reading at the specified cell and return when an 'RE command is encountered. You cannot have an 'RE without a preceding 'CA. You can use these two commands to nest subroutines up to 16 levels.

'RE You use the "return" command to end a subroutine and return to the macro that called the subroutine. When Multiplan encounters a return command in a macro, it returns to just after the last call command, and continues to run that macro. You cannot have an 'RE without a preceding 'CA.

'QU Use the Quit command to end a macro. When Multiplan encounters 'QU, it stops running the macro and returns to command mode.

Command codes

'AL message cell reference This is an interactive command code. You use it to prompt the user for text (alpha) input. Multiplan displays a message on the third line of the command menu, then waits for keyboard input. The user types in the text asked for in the message and presses the RETURN key. When the RETURN key is pressed, Multiplan puts the text into the cell specified in the cell reference. The message must be no more than 78 characters long.

'VA message cell reference This is an interactive command code. You use it to prompt the user to input a value. Multiplan displays the message on the third line of the menu, then waits for keyboard input. The user types a numeric value and presses the RETURN key. Multiplan puts the value into the cell specified in the cell reference. If the expression does not produce a numeric value, Multiplan will display an error message. As with the 'AL command code, the message you want displayed must be no more than 78 characters long.

'LA comment This command is used to insert comments into the macro. They are not executed, and it will not halt the macro process. With this command, you can put comments inside the macro instead of in a column next to the macro. This is important if you write macros that are more than one column wide.

'MN cell reference You can use this command to create your own menus. Menus you create with this command appear in place of the command menu and operate the same way as standard Multiplan menus.

An 'MN command in a macro will move Multiplan to the specified cell reference. This reference is the cell in the upper left corner of a range that must be 2 rows high by 2 to 8 columns wide.

You put labels in the first row of the range. These labels will be menu items in the first line of the menu.

You put longer menu descriptions in the second row. The appropriate menu description will appear on the message line when the corresponding menu item in the first line is highlighted. You highlight menu items with the TAB and BACKSPACE keys.

You choose a menu item by highlighting it and pressing the RETURN key. You can also choose a menu command by typing the first letter of the menu item. If there are two or more commands with the same first letter, Multiplan will run the first one it encounters.

When you choose a menu item, Multiplan moves to the cell below the long menu description, and continues reading.

If you want a menu choice to run a macro, you would start writing the macro in the cell below the long menu description. Then, when you choose that menu item, Multiplan will automatically run the correct macro.

Multiplan will not automatically return to the the macro containing the 'MN command code. To continue reading after the 'MN, you either put a 'GO command code in the appropriate place of the macro that was run when you chose a menu item, or use the 'MC command code (described below) instead of the 'MN command.

If you press ESCAPE at a menu created by an 'MN or 'MC (see below) command code, Multiplan cancels the menus and returns to the point in the macro just after the 'MN or 'MC command code, and continues reading there.

To stop running a macro during an 'MN or 'MC command code, you must press ESCAPE twice; once to cancel the menu and return to the macro, and a second time to cancel the macro. If 'MN or 'MC commands are nested several levels deep, you may have to press ESCAPE more than two times.

'MC cell reference' This command code works the same way as 'MN in every way but one. With this command code, when Multiplan comes to the end of a macro in a menu, it returns to the macro just after the 'MC command code that called up the menu, and continues reading there.

Note When you use command codes, you cannot split them in the middle and put them in separate cells. The entire command code must be in one cell. You can have more than one command code in a cell, but never part of one.

A Second Example

This example shows a more complex macro. In this example, you want to keep a six-month moving average of sales for three products. Your worksheet might look like this:

ITEM #							6-Month
	Jan	Feb	Mar	April	May	June	Moving Average
043	*****	*****	*****	*****	*****	*****	*****
	\$124	\$153	\$163	\$141	\$165	\$186	\$932
045	\$110	\$132	\$121	\$97	\$105	\$114	\$679
065	\$210	\$243	\$275	\$231	\$219	\$225	\$1,403
	*****	*****	*****	*****	*****	*****	*****
TOTAL	\$444	\$528	\$559	\$469	\$489	\$525	\$3,014

You want to write a macro that automates each month's updating and data entry.

The task of updating can be broken down into two parts, opening room for the newest month's figures, and entering those figures. It will be easier to write a macro for this task if we also break the macro down into two parts.

The first task for your macro is to open room for the newest month's figures. You do this by copying the five most recent months one column left. there is no need to erase the oldest month, because it will disappear when copied over.

A macro for this task would be written:

Macro element	What it does
c	Chooses the Copy command.
f	Chooses the From subcommand.
r3c3	Identifies the upper left cell of the range to be copied.
:	Range operator.
r17c7	Identifies the lower right cell of the range.
'tb	TAB
r3c2	Identifies the cell where Multiplan starts copying the range.
'rt	RETURN to carry out the command.

The illustration below shows what would happen if you ran just this first part of the macro.

ITEM #	Mar	April	May	June	June	6-Month Moving Average
043	\$153	\$163	\$141	\$165	\$186	\$994
045	\$132	\$121	\$97	\$105	\$114	\$683
065	\$243	\$275	\$231	\$219	\$225	\$1,418
TOTAL	\$528	\$559	\$469	\$489	\$525	\$3,095

The five most recent months, February through June in this example, are copied one column to the left. The month in column 7, June, is not removed because you can enter the new month, July in this case, right over it.

If you were keeping a twelve-month average instead of six, you might find it difficult to enter the correct figures because the list of product numbers is not on the screen. Or perhaps you have to keep track of hundreds of products, or you want someone else to enter the data.

The second task for your macro, then, is to make it easier for you and others to enter data correctly. You do this by adding command codes to make your macro interact with the user. When you use command codes, remember not to split them in the middle. You must put the entire command code in the cell in which you begin it.

Add the following to your macro:

Macro element	What it does
'al Type the new month and press Return 'r3c7'	Displays the message in the command area, waits for the keyboard input, then puts that input in the correct cell (R3C7).
'va Type unit sales for item 043 and press Return 'r5c7'	Puts the sales figure in the correct cell.
'va Type unit sales for item 045 and press return 'r6c7'	Same function.
'va Type unit sales for item 065 and press Return 'r7c7'	Same function.
'qu	To quit.

This macro will now automate the chore of monthly updates. The next illustration shows what the worksheet might look like after running the entire macro.

ITEM #	6-Month						Moving Average
	Feb	Mar	April	May	June	July	
043	\$153	\$163	\$141	\$165	\$186	\$214	\$1,022
045	\$132	\$121	\$97	\$105	\$114	\$142	\$711
065	\$243	\$275	\$231	\$219	\$225	\$239	\$1,452
TOTAL	\$528	\$559	\$469	\$489	\$525	\$615	\$3,185



Appendix B

Solving Extended Problems with the Iteration Option

The Microsoft Multiplan electronic worksheet includes an option that extends the number of solvable problems.

Consider this example. Spencer Ceramics must pay a bonus that is equal to 10% of its profits. The bonus is calculated then subtracted from the profits to yield the net profit.

Set up this simple calculation in Multiplan as follows (the "Suggested Steps" column is just one way to enter data on the worksheet).

Entries	Suggested Steps
Move cell pointer to R1C1	Press the HOME key
Enter <i>Gross P</i> in R1C1	Press A, type <i>Gross P</i> , press DOWN
Enter <i>Bonus</i> in R2C1	Type <i>Bonus</i> , press DOWN
Enter <i>Net P</i> in R3C1	Type <i>Net P</i> , press RETURN
Name R3C2 as <i>Net_P</i>	Press N, TAB, RIGHT, RETURN
Name R2C2 as <i>Bonus</i>	Press UP, N, TAB, RIGHT, RETURN
Name R1C2 as <i>Gross_P</i>	Press UP, N, TAB, RIGHT, RETURN
Enter 1000 in R1C2	Press RIGHT, type 1000, press DOWN
Enter $Gross_P * 10\%$ in R2C2	Type $=Gross_P * 10\%$, press DOWN
Enter $Gross_P - Bonus$	Type $=Gross_P - Bonus$, press RETURN
Format column 2 to \$	Press F, C, type C2 Press TAB, TAB, \$, RETURN

At this point, your screen looks like:

Gross P	\$1000.00
Bonus	\$100.00
Net P	\$900.00

This bonus is calculated on the gross profits. But the contract calls for the bonus to be calculated on the net profit instead of the gross. You may try to change the worksheet so you can enter *Net_P*10%* in R2C2.

- 1 Press UP, V
- 2 Type *Net_P*10%*
- 3 Press RETURN

Multiplan displays the error message:

Circular references unresolved

The error message indicates a more complicated calculation that requires a different approach. The bonus calculation depends on the net profit. The net profit, in turn, depends on the size of the bonus, which must be subtracted from gross profit to get net profit; a seemingly endless circle. To solve the problem on paper, we would set up an equation and use algebra to find the bonus from the gross profit. Once the equation is set up, the bonus can be calculated manually or using any calculator.

Starting iteration

Instead of spending time setting up complex algebraic formulas, you can let Multiplan automatically solve this extended problem without algebra, as follows:

- 1 Press O (for Options)
- 2 Make sure "Yes" is selected in the "recalc" field
- 3 Press TAB twice to move to the "iteration" field
- 4 Press Y (for "Yes")
- 5 Press RETURN

The numbers on the screen change in rapid succession until they become \$90.91 for Bonus and \$909.09 for Net P. These are the solutions. If you change the gross profit to \$1100, Multiplan quickly recalculates the new bonus as \$100 and the net profit as \$1000. The "Circular references unresolved" error message does not reappear.

What happened? Multiplan used iteration to calculate the solution. To iterate means to repeat a calculation using the results of the previous calculation instead of an unknown quantity. Of course, previous results do not solve the problem exactly, but each iteration produces results that fit better. In the Spencer Ceramics example, the solution was produced as follows.

Just before the first iteration, we had the initial values:

.Bonus \$90.00

Net P \$900.00

The calculations then progressed as follows:

90				
900	$900 * .1 = 90$			
	$1000 - 90 = 910$	$910 * .1 = 91$		
		$1000 - 91 = 909$	$909 * .1 = 90.9$	
			$1000 - 90.9 = 909.1$	

...and so on.

When iteration causes values to become more precise, the process is called “convergence.” Not all models converge. Some models converge only partially. Convergence may also depend on the initial values as well as on the model. Unless you specify otherwise, however, Multiplan stops iterating when the maximum change in all cell values on the worksheet is less than 0.001. This limit assures that the results are precise at least to the penny or percent without jeopardizing the chances for normal termination.

If, for some reason, a model fails to converge within the limit, pressing the CANCEL key interrupts the recalculation at the end of the iteration that is in progress (see the description of the Options command below).

In the next section, you’ll find descriptions of the Multiplan command and functions for controlling iteration: the Options command, and the ITERCNT and DELTA functions.

Following that, you’ll find examples of some useful iterative worksheets; one for an Income Statement and Balance Sheet, one for calculating the Internal Rate of Return (IRR), and one for finding roots of equations using the binary search technique.

Finally, you’ll find a summary of hints for creating iterative models.

For more information on the mathematical theories of iterative methods, consult any handbook on numerical analysis.

Convergence

The Iteration Option and Supporting Functions

Multiplan enters an iteration phase at the end of any normal worksheet recalculation if the following conditions exist:

- The worksheet contains at least one circular chain of references.
- The “iteration” field of the Options command is set “Yes.”
- The completion test (see below) is not TRUE at the end of the first recalculation.

The Options command and two functions (DELTA and ITERCNT) support the iteration option.

Options

Iteration option

```

OPTIONS recalc: Yes No      mute: Yes No
          iteration: Yes No  completion test at:
Select option

```

See the Options command in Chapter 9, “Commands,” for details of the “recalc” and “mute” fields.

Select “Yes” in the “iteration” field if you want to calculate values from formulas that form a circle of references. Select “No” in the “recalc” field while making new entries to the worksheet. This saves time when entering or changing values. Also, selecting “No” in the “recalc” field instead of in the “iteration” field prevents Multiplan from displaying the “Circular references unresolved” error message.

Completion test

In the “completion test at” field, you enter an absolute or name reference to the cell that contains a completion test. A completion test is a formula in the cell that returns a logical value (TRUE or FALSE). Multiplan tests the value of the cell after each iteration. If the value is TRUE, Multiplan stops iteration. If the value is FALSE, Multiplan continues iteration. See the DELTA and ITERCNT functions for more details about completion tests.

Storing the test formula in a cell lets you store and display a complex test as a part of the worksheet. If you leave the “completion test at” field blank, Multiplan applies the formula $\text{DELTA}() < 0.001$ as the convergence test (see the DELTA function below for details).

Stepping through an iteration model one iteration at a time permits debugging and illustrating an iterative solution. To set this up, enter as a response in the “completion test at” field an absolute or name reference of a cell that contains the TRUE() function. This means that Multiplan calculates the model only once. And, repeatedly pressing the RECALC key produces a step-by-step solution.

Pressing the CANCEL key stops iteration. Other keys are ignored during iteration. Multiplan checks for the CANCEL key at the beginning of each iteration. If you press the CANCEL key during an iteration, Multiplan completes that iteration, checks the completion test, and finally (if the completion test is not TRUE) stops iteration and displays the “Circular references unresolved” error message.

The responses in the Options command “iteration” and “completion test at” fields are saved with the worksheet in Normal mode (see the Transfer Options command in Chapter 9, “Commands”). When you load a worksheet that contains an iterating model, the fields of the Options command receive the responses saved with the worksheet. If you later start another sheet, you may want to reset “iteration” to “No” and delete the response in the “completion test at” field.

Example

To cause Multiplan to recalculate the worksheet using iteration and to place a completion or convergence test in R20C5, which you have named “Done”:

```
OPTIONS recalc:(Yes)No      m.ite: Yes(No)
        iteration:(Yes)No  completion test at: Done
```

See “Creating Iteration Models” later in this chapter for actual models that include iteration.

Stopping iteration

DELTA()**DELTA()****Description**

Returns the maximum absolute value of the changes in values from one iteration to the next. Returns #N/A if "No" is selected in the "iteration" field. Multiplan counts only the values in the cells that it evaluates between two successive DELTA functions. The DELTA function returns the #N/A error value when $ITERCNT()=1$ or when $ISNA(ITERCNT())$ returns TRUE (that is, during the first calculation of a circular model) because no previous values exist from which to calculate changes.

You can enter the DELTA function in a convergence test formula to calculate the results of an iteration to any desired precision. For example: $DELTA() < 0.000001$ returns TRUE when convergence results are less than 0.000001.

Each time Multiplan encounters a DELTA function, it resets the internal DELTA value to 0. By entering more than one DELTA function, you can isolate the maximum change in a particular part of the worksheet. To create a DELTA() that only applies to the differences of a part of the worksheet, bracket the cells with cells that contain the DELTA function. Each DELTA() resets the DELTA value to 0. To avoid problems with order of evaluation, enter the first DELTA function in the cell immediately above the block of cells for which you want a local DELTA value. Then, enter the test DELTA formula in the cell immediately below the block of cells to return a local DELTA value.

The following sketches illustrate these guidelines:

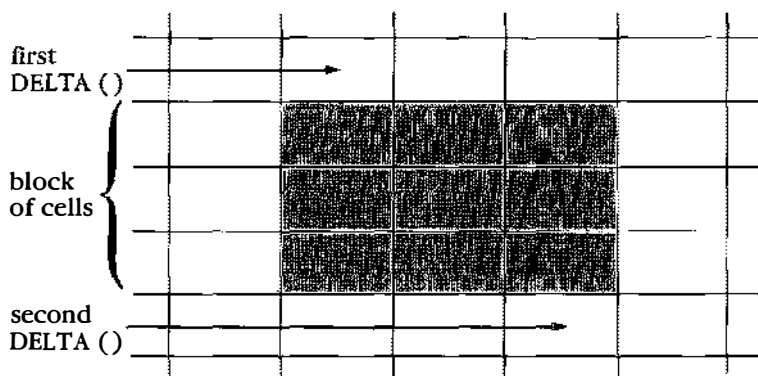

Multiplan recalculates the block of cells column by column. This model provides local values of DELTA only if these columns contain no other circular references. The next sketch illustrates a better model design.

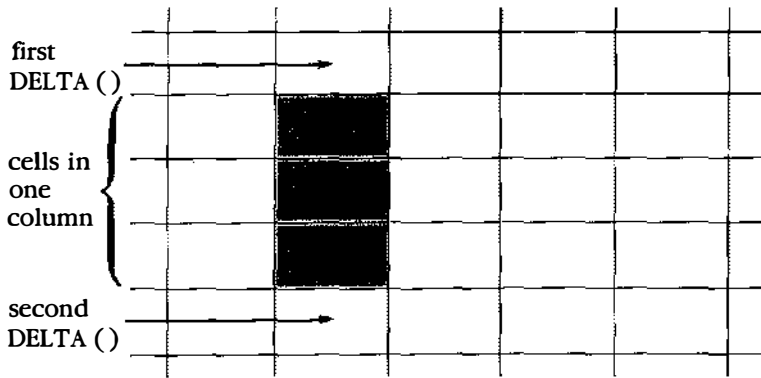

Note that subsequent evaluations of the second DELTA function normally include change to the cell with the first DELTA function. The simple formula DELTA() is usually not sufficient to isolate local values of DELTA. Instead, enter a formula such as: IF(TRUE(),"",DELTA()) which clears the maximum DELTA value while appearing blank on the screen and presenting no value for the following DELTA to evaluate.

Note that if you enter the DELTA function as a completion test and the ITERCNT function by itself in a model (see the ITERCNT function), you may create divergence. The DELTA function also reads the cell that contains the ITERCNT function. Because ITERCNT changes by 1 during each iteration, DELTA will always return at least 1 unless you set up the worksheet model to return local values of DELTA or you eliminate the ITERCNT formula. Note that the formula ITERCNT() $>$ 20 returns TRUE or FALSE after each iteration and therefore would not affect convergence.

Example

Take the simple example of Spencer Ceramics given at the beginning of this appendix, but now calculate the results to the nearest dollar instead of to the nearest penny:

- 1 Enter $DELTA() < 1$ in R4C2.
- 2 Select the Options command and enter R4C2 in the “completion test at” field.

This gives a TRUE value when the difference between the previous and the current result is less than one dollar.

- 3 Now, enter 1000 in R1C2, the gross profit cell.

The results that Multiplan returns are not the same as before, but are now within one dollar of *the more accurate (to-the-penny) result*; that is, Bonus is now \$90.90 instead of \$90.91 (\$90.90 is the first result that had less than a \$1 change from the previous result—\$91). (Refer to the series of calculations that iteration produced in the Spencer Ceramics example.)

See “Creating Iteration Models” below for actual models that include the DELTA function.

INTERCNT()

ITERCNT()

Description

Returns the current iteration count, starting with 1 for the first iteration. During the first recalculation after each change to the worksheet, ITERCNT returns the #N/A error value.

The ITERCNT function is especially helpful for providing initial values for iterative models, for creating a table of iteration results, and for providing a completion test.

Initial Values Many worksheet models require an explicit initial value. Yet, during subsequent iterations, the model requires a formula. To arrange this, substitute a conditional formula (with the IF function) in place of the formula that requires an initial value.

For example, as in the Spencer Ceramics example, to start with an initial value of Initial_Net_Profit, then switch to the formula Gross_Profit–Bonus, enter the formula:

```
IF(ISNA(ITERCNT()),Initial_Net_Profit,
Gross_Profit–Bonus)
```

IF selects Initial_Net_Profit when the condition is TRUE; that is, when ITERCNT() returns the #N/A error value (which it does during the first recalculation after each change to the worksheet), the ISNA() function returns TRUE. After that, ITERCNT returns a number, making ISNA return FALSE; then, IF selects the formula Gross_Profit–Bonus.

Table of Iteration Results You can create a table of partial results from an iteration by copying the formula:

```
IF(ITERCNT()=ROW()-9,Net_Profit,RC)
```

into successive rows starting at row 10. Note that each row receives the value of Net_Profit during a particular iteration and stays unchanged (RC) for all other iterations, before and after.

Completion Test Enter a formula that includes ITERCNT to limit the number of iterations. For example, enter the formula:

```
ITERCNT(>)20
```

Enter the absolute or name reference to the cell that contains this formula in the “completion test at” field of the Options command. During subsequent recalculations, Multiplan completes 20 iterations then stops.

Initial values

Table of iteration results

Creating iteration models

Creating Iteration Models

Iteration is a powerful problem-solving tool. To illustrate using iteration, we provide three examples. Before you begin to study the examples, you should be aware of the order of evaluation Multiplan follows during iteration.

Unlike Multiplan worksheet models without iteration, models with iteration must take into account the order of evaluation of each cell. During iteration the current values of cells referred to in the formulas affect the iteration. Fortunately for the worksheet builder, the order of evaluation of cells participating in circular references is strictly defined when `ITERCNT()>=1`. Multiplan always calculates these cells one column at a time, top to bottom, starting with the first cell of the first column.

A general guideline that helps avoid problems is to place all the circular references in a single column. Care must also be taken that the ordering is correct for iterative methods such as Newton's method (see Example 2, below) and binary search (see Example 3, below). In some situations, the order of evaluation determines whether the solution converges or diverges. If the original order of evaluation does not converge, reconsider the order to get convergence.

**Example 1
Financial Gap Model**

Financial gap model

Integrated Income Statement and Balance Sheet We based the discussion of this example on the following model. If you want to recreate the model, the formulas, text, and data appear following the discussion.

	1	2	3	4	5	6
1 sales		\$100.00	\$300.00	\$800.00		
2 costs		\$50.00	\$420.00	\$620.00		
3 profit		\$50.00	(\$120.00)	\$180.00		
4 int income			\$3.89	\$23.21		
5 int expense			\$0.00	\$0.00		
6 net profit		\$50.00	(\$116.11)	\$203.21	delta	0.000415
7 beg ret earns		\$75.00	\$125.00	\$8.89	itercnt	13
8 end ret earns		\$125.00	\$8.89	\$212.00		
9 cash		\$10.00	\$10.00	\$10.00		
10 funds surplus		\$155.00	\$38.89	\$232.10	done	TRUE
11 total assets		\$165.00	\$48.89	\$242.10	max i	50
12					max d	0.001
13 liabilities		\$40.00	\$40.00	\$30.00		
14 funds deficit		\$0.00	\$0.00	\$0.00		
15 tot liab		\$40.00	\$40.00	\$30.00		
16 tot liab + re		\$165.00	\$48.89	\$242.10		
17 difference		\$0.00	\$0.00	\$0.00		
18 funds			\$38.89	\$232.10		

This model shows a common business application of iteration. Throughout, this model contains examples of one result depending on the result of another calculation in a circular pattern. That is the situation that iteration handles.

Entries and calculations on a balance sheet must satisfy the condition:

total	=	total	+	retained
assets		liabilities		earnings

To achieve this balance, you vary the funds surplus and the funds deficit. This is an iterative process because varying the funds alters the interest, which affects the profits, which changes the retained earnings. This circle of calculation throws the sheet back out of balance.

Funds surplus and funds deficit both refer to the value in the "funds" line (R18). Either funds surplus or funds deficit will always equal 0. If the value in the "funds" line (R18) is positive, you have funds surplus. If this value is negative, you have funds deficit.

Notice the formulas (in the next section) for funds surplus and funds deficit. For funds surplus, the formula $\text{MAX}(0, \text{funds})$ returns the value of funds only if funds is positive; otherwise, it

returns 0. For funds deficit, the formula $-\text{MIN}(0,\text{funds})$ returns the absolute value of funds when funds is negative.

Notice also the formula $\text{IF}(\text{TRUE}(),\text{""},\text{DELTA}())$ in R8C6. This formula keeps the $\text{ITERCNT}()$ function in R7C6 from interfacing with the $\text{DELTA}()$ function in R6C6.

The completion test is in R10C6. It checks both the DELTA value and the ITERCNT value. When one of the two returns TRUE (that is, either a maximum DELTA of 0.001 or an ITERCNT of 50), iteration stops.

Columns 3 and 4 show two new time periods. Column 3 shows a large increase in capital outlay and an increase in sales that is not large enough to offset it. Thus, the profit line (R3) shows a loss. In column 4, however, sales have grown enough to offset the capital outlay. The profit line (R3) shows a profit. This is a typical situation in which the effect of a capital outlay on sales is delayed. You can apply these same formulas to analyze how much increase in sales you need to offset a particular capital outlay.

This model can also help you analyze how much money you must borrow at any specific interest rate to receive as much usable funds as you need.

See the listing of the formulas in the next section.

Formulas for the model

Formulas for Integrated Income and Balance Sheet Model

To show the formulas without breaking them across several lines, the worksheet appears in three parts, in a manner similar to the Multiplan method of printing. Columns 1 and 2 appear first, then columns 3 and 4, then columns 5 and 6. Note that the row numbers are the same for each part; that is, enter the six columns side by side.

1	2
1 "sales"	100
2 "costs"	$0.5 * R[-1]C$
3 "profit"	$R[-2]C - R[-1]C$
4 "int income"	
5 "int expense"	
6 "net profit"	$R[-3]C + R[-2]C - R[-1]C$
7 "beg ret earns"	75
8 "end ret earns"	$R[-2]C + R[-1]C$
9 "cash"	10
10 "funds surplus"	155
11 "total assets"	$R[-2]C + R[-1]C$
12	
13 "liabilities"	40
14 "funds deficit"	0
15 "tot liab"	$R[-2]C + R[-1]C$
16 "tot liab + re"	$R[-1]C + R[-8]C$
17 "difference"	$R[-6]C - R[-1]C$
18 "funds"	
19	

3	4
1 300	800
2 $300 + (0.4 * R[-1]C)$	$300 + (0.4 * R[-1]C)$
3 $R[-2]C - R[-1]C$	$R[-2]C - R[-1]C$
4 $0.1 * R[+6]C$	$0.1 * R[+6]C$
5 $0.1 * R[+9]C$	$0.1 * R[+9]C$
6 $R[-3]C + R[-2]C - R[-1]C$	$R[-3]C + R[-2]C - R[-1]C$
7 $R[+1]C[-1]$	$R[+1]C[-1]$
8 $R[-2]C + R[-1]C$	$R[-2]C + R[-1]C$
9 10	10
10 $MAX(0, R[+8]C)$	$MAX(0, R[+8]C)$
11 $R[-2]C + R[-1]C$	$R[-2]C + R[-1]C$
12	
13 40	30
14 $-MIN(0, R[+4]C)$	$-MIN(0, R[+4]C)$
15 $R[-2]C + R[-1]C$	$R[-2]C + R[-1]C$
16 $R[-1]C + R[-8]C$	$R[-1]C + R[-8]C$
17 $R[-6]C - R[-1]C$	$R[-6]C - R[-1]C$
18 $IF(ISNA(ITERCNT()), 0,$ $RC - (R[-7]C - R[-2]C))$	$IF(ISNA(ITERCNT()), 0,$ $RC - (R[-7]C - R[-2]C))$
19	

	5	6
1		
2		
3		
4		
5		
6	"delta"	DELTA()
7	"itercnt"	ITERCNT()
8		IF(TRUE(),"",DELTA())
9		
10	"done"	OR(R[-4]C<R[+2]C,R[-3]C>R[+1]C)
11	"max i"	50
12	"max d"	0.001
13		
14		
15		
16		
17		
18		
19		

Example 2 IRR Model

IRR model

Internal Rate of Return Calculation In Multiplan, the Internal Rate of Return (IRR) of a group of cash flows is the Rate for which

$$\text{NPV}(\text{Rate}, \text{Cash_Flow}) = 0$$

The name Cash_Flow refers to the part of the worksheet that contains the cash flows. There may be many solutions to the IRR equation. The one found by this method will typically be the one closest to the initial estimate.

The following set of formulas automatically searches for the correct Rate. You can include these formulas in any worksheet under the following conditions:

- Enter each of these formulas in a single row.
- When other parts of the model include iteration and the completion test refers to the IRR convergence, also include the method for returning local values of DELTA (see the DELTA function above).

Formulas for IRR Model

1	2	3	4
1			"Cash Flow"
2	"IRR"	IF(ISNA(ITERCNT()), R[+4]C, IF(ABS(RC)>R[+8]C, -(R[+4]C+ITERCNT()/100), IF(R[+2]C=0, RC+SIGN(R[+1]C)*0.000001, RC-R[+1]C/R[+2]C)))	"-----"
3	"NPV"	NPV(IRR,Cash_Flow)	-1000
4	"NPV'"	IF(IRR=0, (NPV(0.001,Cash_Flow) -R[-1]C)/0.001, (NPV(IRR*1.01,Cash_Flow) -R[-1]C)/(IRR*0.01))	300
5			400
6	"EST.IRR"	0.01	300
7			-200
8	"STATUS"	DELTA()<0.01	1000
9			-1000
10	"LIMIT"	500	2000
11			"-----"

For this model, the following names are defined:

IRR=R2C2

Cash_Flow=R3:10C4

The labels represent:

IRR is the Internal Rate of Return.

NPV is the Net Present Value.

NPV' is the first derivative of NPV (used for Newton's method).

EST.IRR is the initial IRR entered by you. An IRR close to 0, such as 1%, usually gives the first positive IRR, which is the one you seek.

STATUS indicates when the calculation is done.

LIMIT is the largest positive IRR to try before trying negative roots.

	1	2	3	4
1				Cash Flow
2	IRR	27%		-----
3	NPV	0.0		-1000
4	NPV'	-2226.3		300
5				400
6	EST.IRR	1%		300
7				-200
8	STATUS	TRUE		1000
9				-1000
10	LIMIT	50000%		2000
11				-----

The following paragraphs explain briefly the mathematical basis of IRR calculation.

Newton's method

Solving the equation $MPV(IRR, \text{Cash_Flow})=0$ for IRR employs the numerical method known as Newton's method. (This method was first published by Sir Isaac Newton in *Principia* (1686) as a solution for a cubic polynomial.) Newton's method solves for an initial estimate that is close to a root of the equation, then extrapolates along the tangent of this root to find its intersection with the x-axis as the next root to try. Iteration continues until either successive x values converge or the value of the function converges on 0.

The tangent of a given equation $f(x)$ is the first derivative $f'(x)$. Therefore, Newton's method for successive approximations is:

$$x_{(n+1)} = x_n - (f(x_n) / f'(x_n))$$

Applying this equation to the solution of the IRR equation produces:

$$IRR_{(n+1)} = IRR_n - \frac{(NPV(IRR_n, \text{Cash_Flow}) / NPV'(IRR_n, \text{Cash_Flow}))}{1}$$

Now, $f'(x)$ becomes:

$$f'(x) = \lim_{\Delta(x) \rightarrow 0} \frac{(f(x + \Delta(x)) - f(x)) / \Delta(x)}$$

In our case, with a $\Delta(x)$ of 0.01 of x , the equation becomes:

$$\text{NPV}(\text{IRR}_n, \text{Cash_Flow}) = (\text{NPV}(\text{IRR}_n + (\text{IRR}_n * 0.01), \text{Cash_Flow}) - \text{NPV}(\text{IRR}_n)) / (\text{IRR}_n * 0.01)$$

This general method solves many equations that have more than one root, although you must realize that this method may converge to a root different from the expected root or may even diverge if the starting value is not close enough to the root. In the case of IRR, the first root found that is greater than zero is normally the correct answer.

Example 3 Binary Search Model

Binary Search to Find Roots of Equations The IRR formulas in the last section readily adapt to finding the roots of arbitrary equations using the binary search technique.

Assume that you have a polynomial $x^3 + 4x^2 + 5$. Further suppose that you want to solve for a value of x that yields a result of 30. The following model solves for one root of the polynomial using the binary search technique.

Binary search model

	1	2	3
1	"f(x)"	"c_low"	"c_high"
2	$x^3 + 4x^2 + 5$	IF(ISNA (ITERCNT()), low, IF(fx>res, RC,x))	IF(ISNA (ITERCNT()), high, IF(fx<res, RC,x))
3			
4			
5	"result"		
6	30		
	4	5	6
1	"x"	"low"	"high"
2	(c_low+c_high)/2	0	100

For this model, the following names are defined:

c_low	=	R2C2	(current low value)
c_high	=	R2C3	(current high value)
x	=	R2C4	
low	=	R2C5	(low value entered by you)
high	=	R2C6	(high value entered by you)
fx	=	R2C1	
res	=	R6C1	(your desired result; you enter)

Order of operations

The calculation proceeds as follows:

- 1 In cell R2C2, Multiplan evaluates the IF function. During the first iteration, the ITERCNT function returns the #N/A error value, making the ISNA function return TRUE. Thus, IF selects the value of “low,” which in this model is 0.
- 2 For all other iterations, ITERCNT returns an integer, making ISNA return FALSE. Thus, IF selects the “Else” value, which is another conditional formula.
- 3 The second IF formula in R2C2 compares the result of using the value of “x,” (calculated in R2C4) in the polynomial $f(x)$ in R2C1 with the desired result, 30, in R6C1. If the value of $f(x)$ is more than 30, IF selects the current value of the cell (for the second iteration, 0). If the value of $f(x)$ is less than 30, IF selects the value of “x” calculated in R2C4.
- 4 The same steps apply to the conditional formula in R2C3, except that this formula selects the “high” value during the first iteration. During subsequent iterations, IF selects the current value of the cell if $f(x)$ is less than 30, or the value of “x” in R2C4 if $f(x)$ is more than 30.

Once Multiplan begins iteration, the calculations proceed rapidly, and it is difficult to see the numbers clearly before they change.

The following list of values for each cell describes, in part, what happens as Multiplan iterates toward a result:

	1	2	3
1		0	
2		0	100
3		0	50
4		0	25
5		0	12.5
6		0	6.25
7		0	3.125
8		1.5625	3.125
...			
16	29.999762	2.0352602	2.035284

	4	5	6
50	0		100
25	0		100
12.5	0		100
6.25	0		100
3.125	0		100
1.5625	0		100
2.34375	0		100
2.0352721	0		100

At this point, iteration stops because the maximum change in any value is less than 0.001, the internal DELTA value of Multiplan. The root Multiplan calculated is 2.0352721. (The changing values for $f(x)$ in column 1 are left to you to find.)

For more precision, enter a DELTA formula in a cell that sets a limit smaller than 0.001. Or, enter an ITERCNT formula that sets a limit higher than 16. Then, enter either an absolute reference to that cell or the name of the cell in the "completion test at" field of the Options command.

Summary of Hints for Creating Iteration Models

Hints for creating models

■ Order of Evaluation

Unlike Multiplan worksheet models without iteration, models with iteration must take into account the order of evaluation of each cell. During iteration the current value of cells referred to in the formulas affects the iteration. Fortunately for the worksheet builder, the order of evaluation of circular references is strictly defined when `ITERCNT()>=1`. Multiplan always calculates the circular references one column at a time, top to bottom, starting with the first cell of the first column.

A general guideline that helps avoid problems is to place all the circular references in a single column. Care must also be taken that the ordering is correct for iterative methods such as Newton's method (see Example 2, above) and binary search (see Example 3, above).

For solving simultaneous equations, order is less critical because Multiplan assumes that each iteration converges on the solution. However, in some situations the order of evaluation determines whether the solution converges or diverges. If the original order produces divergence, rearranging the order may bring about convergence.

■ Providing for Initial Values

As discussed in the section on the `ITERCNT` function, you may enter a conditional formula to provide an initial value for formulas on the worksheet. For example, because `ITERCNT()` returns `#N/A` the first time it is called, a simple IF statement such as: `IF(ISNA(ITERCNT()),initial_value,formula)` provides `initial_value` for the first calculation, then the formula in subsequent iterations.

■ Obtaining Local Values of DELTA

To obtain a `DELTA()` that applies only to the differences of a part of the worksheet, bracket the cells with cells that contain the `DELTA` function. Each `DELTA()` resets the `DELTA` value to 0. To avoid problems with order of evaluation, enter the first `DELTA` function in the cell immediately above the block of cells for which you want a local `DELTA` value. Enter a formula such as: `IF(TRUE(),"",DELTA())` which clears the maximum `DELTA` value while appearing blank on the screen. Then, enter the test `DELTA` formula in the cell immediately below the block of cells to return a local `DELTA` value. See the section on the `DELTA` function for further details.

- **ITERCNT() and DELTA() Interaction.** If you enter both the DELTA function with a specific limit and the ITERCNT function as a formula by itself in a model, you may create divergence. The DELTA function also reads the cell that contains the ITERCNT function. Because ITERCNT changes by 1 during each iteration, DELTA will always return at least 1 unless you set up the worksheet model to return local values of DELTA or you eliminate the ITERCNT formula. Note that the formula `ITERCNT()>20` returns TRUE or FALSE after each iteration and therefore would not affect convergence.
- **Single Stepping Iteration Models**

Stepping through an iteration model one iteration at a time permits debugging and illustrating an iterative solution. To set this up, enter as a response in the “completion test at” field an absolute or name reference of a cell that contains the TRUE() function. This means that Multiplan calculates the model only once. And, repeatedly pressing the RECALC key produces a step-by-step solution.

General Information

The responses in the Options command “iteration” and “completion test at” fields are saved with the worksheet in Normal mode (see the Transfer Options command in Chapter 9, “Commands”). Thus, when you load a worksheet that contains an iterating model, the fields of the Options command receive the responses saved with the worksheet. If you later start another sheet, you may want to reset “iteration” to “No” and delete the response in the “completion test at” field.

Pressing the CANCEL key stops iteration. Only the CANCEL key has an effect during iteration because all other keys would be entries and are therefore ignored. This also means that any characters you type during iteration are not saved, so the type-ahead feature does not work.

Multiplan checks for the CANCEL key at the beginning of each iteration. Thus, if you press the CANCEL key during an iteration, Multiplan completes that iteration, checks the completion or convergence test, and finally (if the completion or convergence test is not TRUE) stops iteration and displays the “Circular references unresolved” error message. (If the completion or convergence test is TRUE, Multiplan ends iteration as if you had not pressed the CANCEL key.)

1

2

3

Lexicon

Absolute reference A reference to a cell that uses specific row and column numbers; for instance, R17C12. Opposed to relative reference, as R[+1] C[-2].

Action keys Keys that cause Multiplan to carry out an action at once. The action keys include the CANCEL key, NEXT WINDOW key, and RETURN key. *See also* Direction keys, Edit keys.

Active Something in use right now and immediately accessible, such as the active window, active cell, or active field of a command.

Active cell The cell indicated by the cell pointer. The contents of the active cell can be seen on the status line and may be edited with the Edit command.

Active window The window containing the active cell, marked on the screen by a highlighted window number.

Alignment The rule for the horizontal positioning of the display of a cell's value. Values may be left-justified or right-justified or centered.

CANCEL key Action key that causes Multiplan to abandon the current command and return to command choice.

Cell One position on the worksheet, a place where data or a formula may be stored. A cell has a location and may be referred to by one or more names. The contents of a cell determine its value; the cell's format determines how its value is displayed.

Cell pointer A highlighted pointer that selects one cell from all the cells in the worksheet. That cell becomes the active cell. The cell pointer is moved from cell to cell with the direction keys, or directly with the Goto command.

Character A symbol that can be displayed on the screen; includes letters, digits, punctuation, and special characters like \$, +, and %.

A

C

Column A vertical line of cells down the worksheet. There are 255 columns, designated by the numbers 1 through 255.

Command An instruction to Multiplan to do something. A command may have one or more fields in which to specify how the command should be carried out.

Command line The screen lines just under the worksheet area, beginning with the word *COMMAND*;, and showing the main command menu. Here is where commands are built.

Contents (of a cell) That which has been put into a cell. If nothing has been put in, the cell is empty and its contents are blank. Otherwise the cell contains either data (text or a number) or a formula. If a cell contains a formula, the cell's value, which is the result of the formula, is usually displayed.

Cursor *See* Edit cursor.

Dependent sheet A sheet that uses values from another sheet. The dependent sheet depends on information calculated on another, saved, sheet to which it is linked by the eXternal Copy command. *See also* Link.

Direction keys Keys that move the cell pointer. The UP, DOWN, LEFT, and RIGHT keys move the pointer one cell at a time. The HOME key moves it to the cell in the upper left corner of the active window.

Directory The table of file names kept on each diskette by the operating system. The directory lists each file on the diskette.

Edit Altering a response in a field of a command. The edit keys are used to move the edit cursor over the response, and the character keys are used to replace or insert characters.

Edit cursor The highlighted part of a command on the command line, which may be as small as one character or as large as an entire field. The edit cursor is moved with edit keys. It shows where alterations can be made to the command.

Edit keys Keys that move the edit cursor within the command line. They include, for example, the WORD RIGHT and WORD LEFT and CHARACTER RIGHT and CHARACTER LEFT keys.

Field A portion of a command in which you type a response to instruct Multiplan in some detail of the command's work. When Multiplan first shows a field, it fills it with a proposed response; you can replace or edit that response if it isn't what you want.

D

E

F

File A named unit of data stored on disk or diskette. When a worksheet is saved it is written into a file. Not all files are saved worksheets, but those that are can be loaded or linked to other worksheets.

Filename The name used to refer to a worksheet when it is saved, loaded, or linked to another sheet.

Format How a cell's value is displayed. The format controls numeric punctuation and the alignment of the display value. A format can be specified for a cell or cells with the Format Cells command; cells without a specific format are displayed according to a default format set with the Format Default command.

Formula A recipe for how a value is to be calculated. Whenever the contents of a cell are changed, Multiplan recalculates all the formulas on the worksheet (unless automatic recalculation is turned off).

Function A built-in mathematical or statistical operation that Multiplan can perform on one or more values; e.g., SUM or AVERAGE.

Group of cells A collection of one or more cells on the worksheet that may be named; e.g., *Sales*.

Highlight An area on the display that appears emphasized. Highlights are used to indicate the edit cursor, active cell, active window number, and current menu item.

Link In Multiplan, the use of data from an inactive sheet in calculations on the active sheet. The inactive sheet is called the supporting sheet. The data to be copied must have been marked with the Name command or must be specified by an absolute reference. Then data from the supporting sheet may be used in formulas on the active sheet. Link is also used to express connection between windows for synchronized scrolling.

Load To make a saved sheet active again. The sheet to be loaded must have been saved. The Transfer Load command is used to copy the saved sheet from its file to working storage, where it becomes the active sheet.

Lock Protection of cells that contain formulas or text from inadvertent alteration.

Menu A list of alternatives. A choice from a menu is selected in one of two ways: by moving through the list with the space bar (a highlight will move along the menu indicating the current selection) and selecting the highlighted choice with the RETURN key, or by typing the initial letter of the desired item.

G

H

L

M

Message A notice posted by Multiplan on the message line to explain a problem or suggest what kind of input the system is waiting for.

Message line The next to the last line on the display.

Name (of a cell or group of cells) A tag associated with a group of cells by the Name command. The name can be used to refer to the cell or cells in formulas.

NEXT UNLOCKED CELL key Action key that moves the cell pointer to the next cell that is not blank and is not locked. Used to find cells that contain numbers (rather than a formula or text) so you can perform "what if" experiments.

PREVIOUS UNLOCKED CELL key Similar to above, but moves the cell pointer to the previous cell that is not blank or locked.

Proposed response Response supplied by Multiplan. It is usually based on the most recent responses by the user or on the current status of Multiplan.

Range The smallest rectangle of cells containing two references. A range is designated by the colon (:). The range R3:R8 defines the rectangular area containing all of rows 3 to 8, namely, rows 3, 4, 5, 6, 7, and 8. *See also* Reference.

Reference The designation of a cell or an area of cells. The simplest reference is to a single cell: R9C2. A reference may be relative to the cell containing the reference, as in R[-1]C. A reference may be to a single cell, as the prior two, or to an area of cells: R6 refers to all of row 6. A reference may be composed of intersections of references, ranges of references, or unions of references. A reference may be a name defined to refer to one or more cells. *See also* Range and Name.

Relative Reference A reference to a cell relative to the cell containing the reference, as R[-1]C meaning "the row above, in this column." Opposed to absolute reference, in which the actual column and row numbers are stated.

Response What the user types in a field of command. May be a row or column number, a count, a name, or the contents to be put in a cell. When Multiplan displays a command on the command line, it usually supplies a proposed response in every field of the command; the user may replace the proposed response, edit it, or leave it as proposed.

Row A horizontal line of cells across the worksheet. There are 4095 possible rows, designated by the numbers 1 through 4095.

Save The operation of making a permanent copy of the active worksheet in a file.

S

Scroll To move one or more windows across the worksheet one row or column at a time. Scrolling is done with the direction keys. For example, if the RIGHT DIRECTION key is pressed until the cell pointer reaches the right edge of the screen, and then pressed again, Multiplan scrolls the worksheet display one column to the left.

Status line Bottom line of the screen, where Multiplan presents status information such as the location of the active cell and its contents.

Supporting sheet A sheet providing values to another sheet. The sheet supports the other sheet (the dependent sheet) with data that has been designated with the eXternal Copy command. Data on the supporting sheet must have been named with the Name command. *See also* Link.

Text String of characters that may be used for titles in the worksheet. Multiplan formulas can perform operations on text also.

T

Value The information content of a cell: its numeric value if it contains a number; its text if it contains text; or, if it contains a formula, the result of calculating that formula.

V

Window A rectangular portion of the display area within which Multiplan displays a part of the worksheet. As many as eight windows may be open at once; they are opened or closed with the Window command. Each window has a window number from 1 through 8 shown in its upper left corner. The window number of the active window is highlighted; that window contains the active cell, which is highlighted by the cell pointer.

W

Worksheet A grid of cells displayed by Multiplan to store formulas and values.

C

Index

- ABS function 247
- Absolute references 96, 170
- Active cell 7
- Addition operator (+) 167
- Aligning cell contents 37, 51, 74
- Alpha command 25, 27, 186
- ALTERNATE-H key 310
- AND function 248
- ATAN function 249
- Autoexec macro 311
- AVERAGE function 250

- BACKSPACE key 17, 28
- Bar graph, as a formatting code 39
- Base figures 122
- Binary search technique 335
- Blank command 55, 188
- Bordering window 111
- Building
 - formulas 57, 84
 - supporting worksheets 136

- Calculating functions 90
- Calculations
 - automatic 123
 - one-time 124
- CANCEL key 17, 19, 311, 323
- Canceling
 - cell entries 55, 89
 - commands 19
 - macros 311
- Carrying out commands 19
- Cell
 - active 7
 - alignment 37, 51, 74
 - calculation order 159
 - centering contents of 74
 - contents 37, 51, 64, 74
 - copying 75

 - Cell (*continued*)
 - deleting using Blank command 55
 - dependence 159
 - going to 14
 - locating 87
 - locking 210-211
 - names, deleting 89
 - naming 80, 89, 214
 - pointer 7, 8, 205, 206
 - references 168
 - unlocking 121
 - value 159
 - Centering cell contents 74
 - Changing
 - base figures 122
 - column width 32
 - formulas 122
 - CHARACTER LEFT key 165
 - CHARACTER RIGHT key 165
 - Clearing the screen 135
 - Closing windows 108
 - Codes
 - command 308, 313
 - formatting 198
 - key 306, 308
 - Colon (:) range operator 53, 174
 - COLUMN function 251
 - Columns
 - deleting 194
 - headings 25
 - inserting 209
 - moving 212, 213
 - number of 7
 - width 32, 202, 203
 - Comma (,) union operator 175, 202
 - Command
 - codes 308, 313
 - fields 14
 - key sequence 307,310
 - line 18
 - names. *See* Commands

Commands

- Alpha 25, 27, 186
- Blank 55, 188
- canceling 19
- carrying out 19
- Copy 188
- Copy Down 189
- Copy From 100, 190
- Copy Right 75, 116, 192
- Delete 193
- Delete Column 194
- Delete Row 195
- DIR 342
- Edit 195
- entering 161
- eXternal 237
- eXternal Copy 141, 238, 307
- eXternal List 153, 240
- eXternal Total 241
- eXternal Use 243
- Format 36, 74, 196
- Format Cells 197
- Format Default 201
- Format Default Cells 36, 201
- Format Default Width 202
- Format Options 202
- Format Width 32, 203
- formatting 196
- Goto 14, 87, 204
- Goto Macro 205, 310, 311
- Goto Name 87, 205, 311
- Goto Row-col 206
- Goto Window 206
- Help 20, 207
- Insert 47, 208
- Insert Column 209
- Insert Row 210
- Lock 210
- Lock Cells 211
- Lock Formulas 119, 212
- Move 212
- Move Column 213
- Move Row 214
- Name 80, 83, 214, 310
- Options 122, 216, 322
- Print 127, 217
- Print File 130, 217
- Print Margins 130, 218
- Print Options 131, 218
- Print Printer 128, 219

Commands (*continued*)

- Quit 21, 42, 220
- selecting 17, 162
- Sort 184, 221
- subcommands 14, 17, 161, 162
- Transfer 222
- Transfer Clear 135, 223
- Transfer Delete 223
- Transfer Load 45, 69, 224
- Transfer Options xxv, 225
- Transfer Rename 226
- Transfer Save 41, 67, 227
- Value 228
- Window 229
- Window Border 111, 230
- Window Close 230
- Window Link 110, 231
- Window Paint 232
- Window Split 106, 108, 234
- Window Split Horizontal 234
- Window Split Titles 235
- Window Split Vertical 236
- Comments in macros 309
- Completion test 322
- Computer requirements xv
- Concatenation operator (&) 168
- Connections between worksheets 150
- Convergence 321, 323, 324
- Copy
 - command 188
 - Down 189
 - From 100, 190
 - Right 75, 116, 192
- Copying
 - cells 75
 - formulas 100
 - from a supporting worksheet 141
 - messages 149
 - unchanging data 150
 - vectors 190
- Correcting
 - See also* Deleting
 - typing errors 28
- COS function 252
- COUNT function 253
- Creating menus 314
- Cursor 15, 165

Data, entering 29

Debugging 323
Default 197
Defining
 names 139
 macros 306
Delete
 Column 194
 command 193
 Row 195
Deleting 193
 cell names 89
 cells using Blank command 55
 columns 194
 defined names 152
 new text 165
 proposed responses 165
 rows 195
 text 28, 165
DELTA function 323
Dependent
 cells 159
 worksheets 135, 182
DIR command 342
Direction keys 7, 8, 29
Directory xxiii
Division operator (/) 167
DOLLAR function 254
Dollars, displaying numbers as 36
Drawing lines 65

Edit command 195
Edit cursor 15, 165
EDIT MACRO key 309
Editing
 formulas 165
 keys 164
 macros 311
 text 165
Either-or decisions 178
Entering
 commands 161
 data 29
 numbers 34
 text 25, 49, 186
Equal operator (=) 177
Erasing. *See* Correcting, Deleting
Error messages 293
Error values 94, 166, 178
Errors, correcting 28

EXP function 255
Expanding worksheets 47
Exponentiation operator (^) 167
eXternal
 command 237
 Copy 141, 238, 307
 List 153, 240
 Total 241
 Use 243
External relationships between worksheets 181

FALSE function 256
False, logical value 166, 177
Field delimiters 345
Fields, command 14
Figures, base 122
File modes xxvi, 225
Files
 accessing, problems in 180
 handling 179
 listing xxiv
 loading 45
 naming xxi
Filling in the command line 18
FIXED function 257
Fixing titles in place 106
Format
 Cells 197
 command 36, 74, 196
 Default 201
 Default Cells 36, 201
 Default Width 202
 Options 202
 Width 32, 203
Formatting
 cells 38, 197
 commands 39, 198
 entire row or column 74
Formulas
 absolute or relative references 97
 building with names 84
 changing 122
 copying 100
 editing 165
 entering 57, 80
 locking 119, 210, 212
 numbers in 167
Functions
 ABS 247

Functions (*continued*)

AND 248
ATAN 249
AVERAGE 250
calculating 90
COLUMN 251
COS 252
COUNT 253
DELTA 323
DOLLAR 254
EXP 255
FALSE 256
FIXED 257
FV 279
IF 258
INDEX 259
INT 260
IRR 332
ISERROR 262
ISNA 263
ITERCNT 326, 327
LEN 264
LN 265
LOG10 266
LOOKUP 267
MAX 269
MID 270
MIN 271
MIRR 272
MOD 273
NA 274
NOT 275
NPER 279
NPV 276
OR 277
PI 278
PMT 279
PV 279
RATE 279
REPT 282
ROUND 283
ROW 284
SIGN 285
SIN 286
SQRT 287
STDEV 288
SUM 90, 289
TAN 290
TRUE 291, 323
using 92

Functions (*continued*)

VALUE 292
FV function 279

Goto

command 14, 87, 204
Macro 205, 310, 311
Name 87, 205, 311
Row-col 14, 206
Window 206
Graph, bar 39
Greater than operator (>) 177
Greater than or equal operator (>=) 177
Grid number 24

Hard disk, installing Multiplan on xvi

Headings, row and column 25

Help 20, 207

Help command 20, 207

HELP (?) key 20

Highlight 15

HOME key 13

IF function 258

Illegal parameter message 191

INDEX function 259

Insert

Column 209

command 47, 208

Row 210

Inserting

columns 209

new text 165

rows 210

Installing Multiplan xvi

INT function 260

Interactive macros 312

Intersection (space) operator 173

IRR function 332

ISERROR function 262

ISNA function 263

Iteration

binary search 335

creating models with 338

examples of 328

results, table of 327

starting 320

ITERCNT function 326, 327

Key codes 306, 308

Keyboard xvii, 21

Keys

- ALTERNATE-H 310
- BACKSPACE 27, 28
- CANCEL 17, 19, 311, 323
- CHARACTER LEFT 165
- CHARACTER RIGHT 165
- direction 7, 8, 29
- EDIT MACRO 309
- editing 164
- HELP (?) 20
- HOME 13
- NEXT UNLOCKED CELL 119
- NEXT WINDOW 112
- NUMLOCK 353
- PREVIOUS UNLOCKED CELL 121
- RECALC (!) 216
- REFERENCE (@) 116
- RETURN 19
- SINGLE-STEP 311
- Standard xvii-xix
- TAB 16, 18, 163
- WORD LEFT 165
- WORD RIGHT 165

Leaving Multiplan 21, 42

LEN function 264

Less than operator (<) 177

Less than or equal operator (<=) 177

Lines, drawing 65

Linking

- windows 109
- worksheets 143

Listing files xxiv

LN function 265

Loading

- files 45, 184A
- worksheets xxiii, 69

Locating named cells 87

Lock Cells command 211

Lock command 210

Lock Formulas command 119, 212

Locking

- cells 210-211
- formulas 119, 210, 212

LOG10 function 266

Logical values 166, 177

LOOKUP function 267

Lotus files

- loading 184A
- saving 184C

Macros 305

- autoexec 311
- canceling 311
- command codes 308, 313
- comments 309
- defining 306
- editing 311
- enumerating lists of 310
- interactive 312
- key codes 306, 308
- naming 307, 309
- running 310
- spaces in 308
- writing 307

Margins

- preset 127
- printing 218
- setting 130

Mathematical operators. *See* Operators

MAX function 269

Memory xxii, 10

Menus

- creating 314
- selecting from 17

Message

- copying 149
- directory 293
- illegal parameters 191
- line 161, 163

Messages, directory of 293

MID function 270

MIN function 271

MIRR function 272

MOD function 273

Modes, file xxvi, 225

Move

- Column 213
- command 212
- Row 214

Moving

- cell pointer 8, 205, 206
- columns 212-213

Moving (*continued*)

rows 212, 214

msinstall program xvi

Multiplan Program, installing xvi

Multiplication operator (*) 114, 167

Mute option 216

NA function 274

Name command 80, 83, 214, 310

Names

cell 80, 89, 172, 214

defined, deleting 152

defining 139

displaying 215

spelling rules for 172

using to build formula 84

Naming

cells 80, 89, 172, 214

conventions 172

macros 307, 309

related worksheets 140

worksheet 41

NEXT UNLOCKED CELL key 119

NEXT WINDOW key 112

Normal file mode xxvi, 225

Not equal operator (<>) 177

NOT function 275

NPER function 279

NPV function 276

Number

column 7

grid 24

row 7

signs (#) 93-94

Numbers

as dollars 36

entering 34

forms of, in formulas 167

value 166

NUMLOCK key 353

One-time calculation 124

Opening windows 108

Operator precedence 168

Operators

Addition (+) 167

Concatenation (&) 168

Division (/) 167

Operators (*continued*)

Equal (=) 177

Exponentiation (^) 167

Greater than (>) 177

Greater than or equal(>=) 177

Intersection (space) 173

Less than (<) 177

Less than or equal(<=) 177

Multiplication (*) 114, 167

Not equal (<>) 177

Percent (%) 167

Range (:) 53, 174

Subtraction (-) 167

Union (,) 175, 202

Options 216

comma 202

command 122, 216, 322

formulas 202

iteration 319

mute 216

recalc 216

OR function 277

Other file mode 225

Pathname xxiii, xxv

Percent operator (%) 167

PI function 278

PMT function 279

Pointer, cell 7

Preset margins 127

PREVIOUS UNLOCKED CELL key 121

Print command 127, 217

Print File command 130, 217

Print Margins command 130, 218

Print Options command 131, 218

Print Printer command 128, 219

Printing xxv, 127, 217

Proposed responses 14, 18, 163-165

Protecting the worksheet xxiii, 119

PV function 279

Quitting Multiplan 21, 42

Quit command 21, 42, 220

Range operator (:) 53, 174

RATE function 279

Read protection xxiii

- RECALC (!) key 216
- Recalc option 216
- Recalculation 122-124
- Receipts 183
- Redrawing active window 206
- REFERENCE (@) key 116
- References
 - absolute 96, 170
 - cell 168
 - relative 96, 170
- Relating worksheets 135
- Relative references 96, 170
- Replacing
 - proposed responses 164
 - text 165
- REPT function 282
- Responses, proposed 14, 18, 163-165
- RETURN key 19
- Revising supporting worksheet 148
- ROUND function 283
- ROW function 284
- Rows
 - deleting 195
 - headings 25
 - inserting 210
 - moving 212, 214
 - number of 7
- Running macros 310

- Saving
 - print output 217
 - worksheets 41, 67, 184C
- Screen 5, 135
- Scrolling 12
- Selecting
 - commands 17, 162
 - from menus 17
 - subcommands 162
- Setting
 - column width 202, 203
 - margins 130
- SIGN function 285
- SIN function 286
- SINGLE-STEP key 311
- Sort command 184, 221
- Sorting 221
- Space bar 17
- Space (intersection operator) 173
- Spaces in macros 308

- Spelling rules for names 172
- Splitting windows 106
- SQRT function 287
- Starting Multiplan xvii
- Status line, cell contents in 64
- STDEV function 288
- Storing worksheet 130
- Subcommands 14, 17, 161, 162
- Subtraction operator (-) 167
- SUM function 90, 289
- Supporting worksheets
 - building 136
 - copying from 141
 - revising 148
- Symbolic file mode xxxvi, 225
- Symbols. *See end of index*
- Symphony. *See Lotus files*
- System requirements xv

- TAB key 16, 18, 163
- TAN function 290
- termcap* file xxvii
- Terminal capabilities xxvii
- Text
 - deleting 28, 165
 - editing 165
 - entering 25, 49, 186
 - replacing 165
 - values 168
- Titles 70, 106
- Transfer
 - Clear 135, 223
 - command 222
 - Delete 223
 - Load 45, 69, 224
 - Options xxv, 225
 - Rename 226
 - Save 41, 67, 227
- Transforming worksheets 183
- TRUE function 291, 323
- True, logical value 166, 177
- Typing errors, correcting 28

- Union operator (,) 175, 202
- Unlocking cells 121

- Value command 29

VALUE function 292

Values

cell 159

error 94, 166, 178

logical 166, 177

Vectors, copying 190

VisiCalc files, loading 184A

Width, column 32, 202, 203

Window

Border 111, 230

Close 230

command 229

Link 110, 231

Paint 232

Split 106, 108, 234

Split Horizontal 234

Split Titles 235

Split Vertical 236

Windows

bordering 111

closing 108

going to 204

linking 109

opening 108

redrawing active 206

splitting 106

WORD LEFT key 165

WORD RIGHT key 165

Working memory 10

Worksheets

connections between 150

dependent 135, 182

description 159

expanding relationships 181

linking 143

loading xxiii, 45, 69, 184A

naming 41, 140

number grid 24

other program's, loading 184A

protecting 119

related 135, 140

saving 41, 67, 184C

scrolling 12

storing 130

temporary 11

transforming 183

Write protection xxiii

Writing macros 307

XENIX system, installing Multiplan on xvi

Xternal. *See* eXternal

+ (Addition operator) 167

- (Subtraction operator) 167

* (Multiplication operator) 167

/ (Division operator) 167

> (Greater than) 177

>= (Greater than or equal) 177

< (Less than) 177

<= (Less than or equal) 177

= (Equal) 177

<> (Not equal) 177

& (Concatenation operator) 168

^ (Exponentiation operator) 167

% (Percent operator) 167

: (Range operator) 174

, (Union operator) 175

? HELP key 20

(number sign) 93-94

Name _____

Street _____

City _____ State _____ Zip _____

Phone _____ Date _____

Instructions

Use this form to report software bugs, documentation errors, or suggested enhancements. Mail the form to Microsoft.

Category

_____ Software Problem

_____ Documentation Problem
(Document # _____)

_____ Software Enhancement

_____ Other

Software Description

Microsoft Product _____

Rev. _____ Registration # _____

Operating System _____

Rev. _____ Supplier _____

Other Software Used _____

Rev. _____ Supplier _____

Hardware Description

Manufacturer _____ CPU _____ Memory _____ KB

Disk Size _____" Density: Sides:

Single _____ Single _____

Double _____ Double _____

Peripherals _____

Problem Description

Describe the problem. (Also describe how to reproduce it, and your diagnosis and suggested correction.) Attach a listing if available.

Microsoft Use Only	
Tech Support: _____	Date Received: _____
Routing Code: _____	Date Resolved: _____
Report Number: _____	
Action Taken: _____	



.



